

PREVIEW EDITION
CABINE ARMADIO, LETTI E CONTENITORI

WALK-IN WARDROBES, BEDS AND BEDROOM FURNITURE

TOMASELLA

PREVIEW EDITION

CABINE ARMADIO, LETTI E CONTENITORI

WALK-IN WARDROBES, BEDS AND BEDROOM FURNITURE

SISTEMA CABINE PAG. 02

WALK-IN WARDROBE SYSTEM

SISTEMA APERTURE DOORS PAG. 106

DOOR TYPES

LETTI E CONTENITORI PAG. 120

BEDS AND BEDROOM FURNITURE

PAGINE SINTESI PAG. 158

SUMMARY

SISTEMA CABINE

WALK-IN WARDROBE SYSTEM

Organizzare una cabina armadio è un'ottima soluzione per tenere tutto perfettamente in ordine in un'unica stanza dedicata, agevolando e facilitando così la scelta degli outfit di tutti i giorni e i cambi di stagione. Tomasella propone tre diverse tipologie di cabine armadio, in cui la struttura cambia per adattarsi a spazi, architetture ed esigenze estetiche diverse ma rimangono invariate le ampie possibilità di personalizzazione e l'estrema funzionalità di ogni sistema.

Organising a walk-in wardrobe is a great way to keep everything perfectly tidy in one dedicated room, making it easier and more convenient to choose everyday outfits as the seasons change. Tomasella offers three different types of walk-in wardrobes, in which the structure changes to adapt to different spaces, architectural features and aesthetic requirements. However, the extensive options for customisation and extreme functionality of each system remain unchanged.



PRATICO SYSTEM PAG. 04



DOXA SYSTEM PAG. 46



LIBERTY SYSTEM PAG. 76

PRATICO SYSTEM

Pratico è una cabina armadio composta da boiserie personalizzabili in diverse finiture o grafiche stampate, sulle quali vengono posizionati a piacere diverse soluzioni di attrezzature: cassettiere sospese o a terra, ripiani con Led o accessori estraibili.

Pratico is a walk-in wardrobe consisting of wall panelling, which can be customised in different finishes or in printed graphics. Various internal fittings can be placed as required: wall-hung or floor-standing drawer units, shelves with LED lights or pull-out accessories.





PRATICO COMP_PR101
L/W 247,3 P/D 34,8/59,6 H 255,8 CM
(piccola a sx / small on the left)

PRATICO COMP_PR102
L/W 387,6/396,7 P/D 59,6 H 255,8 CM
(ad angolo / corner version)

Boiserie materico alpaca.
Attrezzature materico noce ambra, laccato
opaco rubino 172 e pesca 157.
Staffe e accessori in metallo antracite.

Textured alpaca wall panelling.
Fittings in textured amber walnut, matt
ruby red 172 and peach 157 lacquer.
Anthracite metal brackets and accessories.





PRATICO COMP_PR101
L /W 247,3 P/D 34,8/59,6 H 255,8 CM

Boiserie materico alpaca.
Attrezzature materico noce ambra, laccato
opaco rubino 172.
Staffe e accessori in metallo antracite.

Textured alpaca wall panelling.
Fittings in textured qmber walnut, matt
ruby red 172.
Anthracite metal brackets and accessories.



La funzionalità di Pratico può essere completata con la cassetiera bicolore Replay che, oltre al contenimento, aggiunge stile alla cabina armadio grazie ai possibili accostamenti cromatici. Il top è rifinito in laccato opaco rubino 172, per dare un ulteriore tocco personalizzato.



The functionality of Pratico can be complemented with the Replay two-tone drawer unit, which not only provides storage space but also enhances the style of the walk-in wardrobe thanks to the colour combinations available. The top is finished with matt ruby red 172, giving it an extra personal touch.

Al centro della stanza e dell'attenzione, l'isola attrezzata in laccato rubino 172 e materico noce ambra crea la tua personale oasi di funzionalità e contenimento: cassetti, vani a giorno e piani di appoggio su entrambi i lati permettono di organizzare tutto al meglio. La cabina armadio è come una vera boutique, dove scegliere ogni giorno gli abiti da indossare e gli accessori da abbinare.

The centrepiece of the room is an accessorised island drawer unit in ruby 172 lacquer, whereas textured amber walnut creates your personal haven of functionality and storage: drawers, open compartments and shelves on both sides let you organise everything in the best possible way. The walk-in wardrobe is like a genuine boutique, where, every day, you can choose the clothes you want to wear and accessories to match.





Il top della cassettera isola in vetro fumè crea un ricercato effetto vedo-non vedo che permette di esporre accessori e altri oggetti senza metterli troppo in mostra. Una soluzione perfetta per tenere a vista le cose che si utilizzano di più e un dettaglio raffinato per completare lo stile dell'arredo.

The smoked glass top of the island drawer unit creates a sophisticated see-through effect, allowing accessories and other items to be displayed without making them too conspicuous. A perfect solution for keeping the things you use most in view and a refined detail for complementing the style of your furniture.

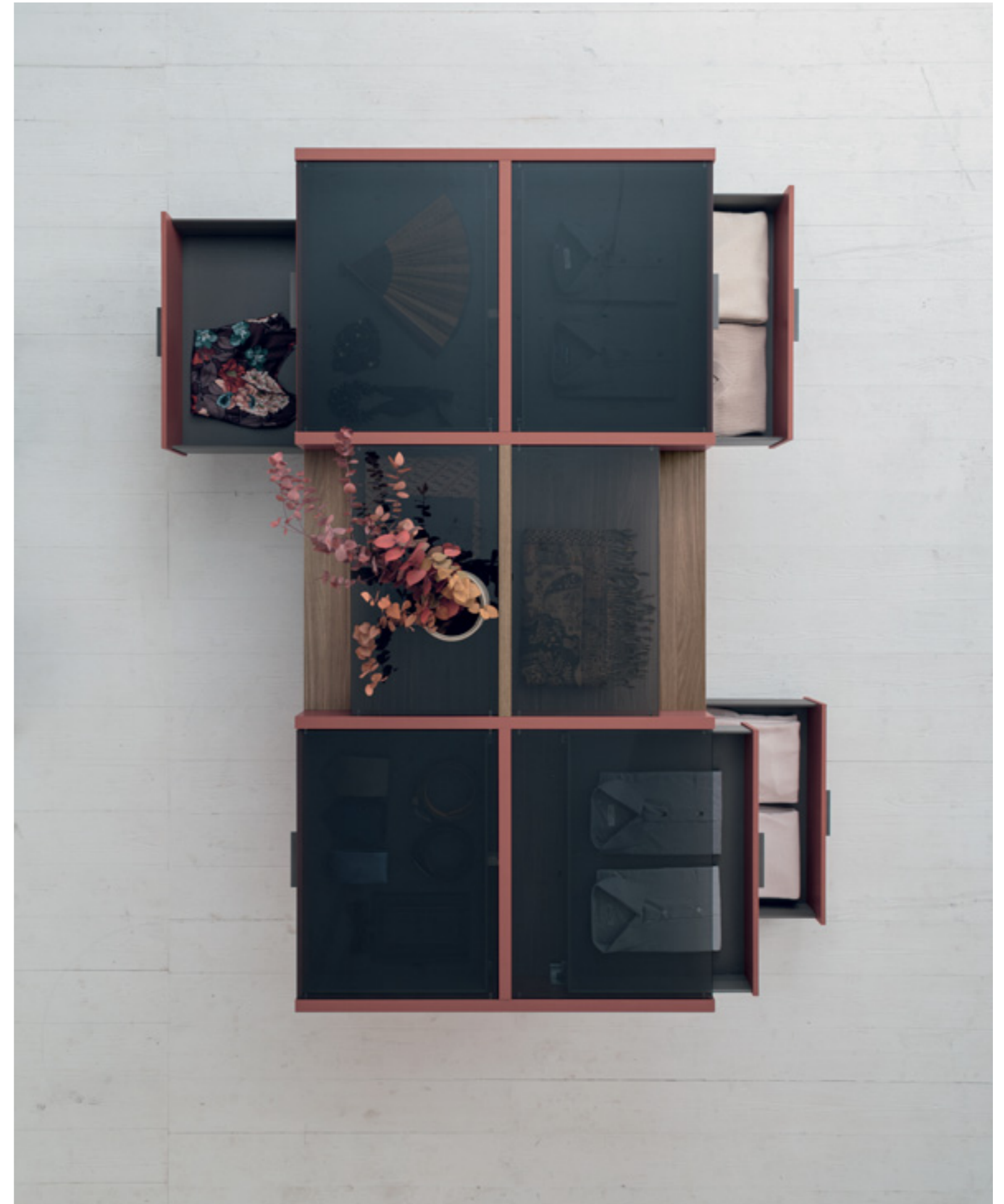







La cabina armadio è composta da attrezzature che aiutano a tenere in ordine e ad ottimizzare lo spazio. Contrariamente ad un armadio tradizionale, qui tutto è a vista quindi, oltre alla funzionalità, anche l'estetica vuole la sua parte: la cassetteria con frontali in vetro fumè alleggerisce l'arredo con stile.

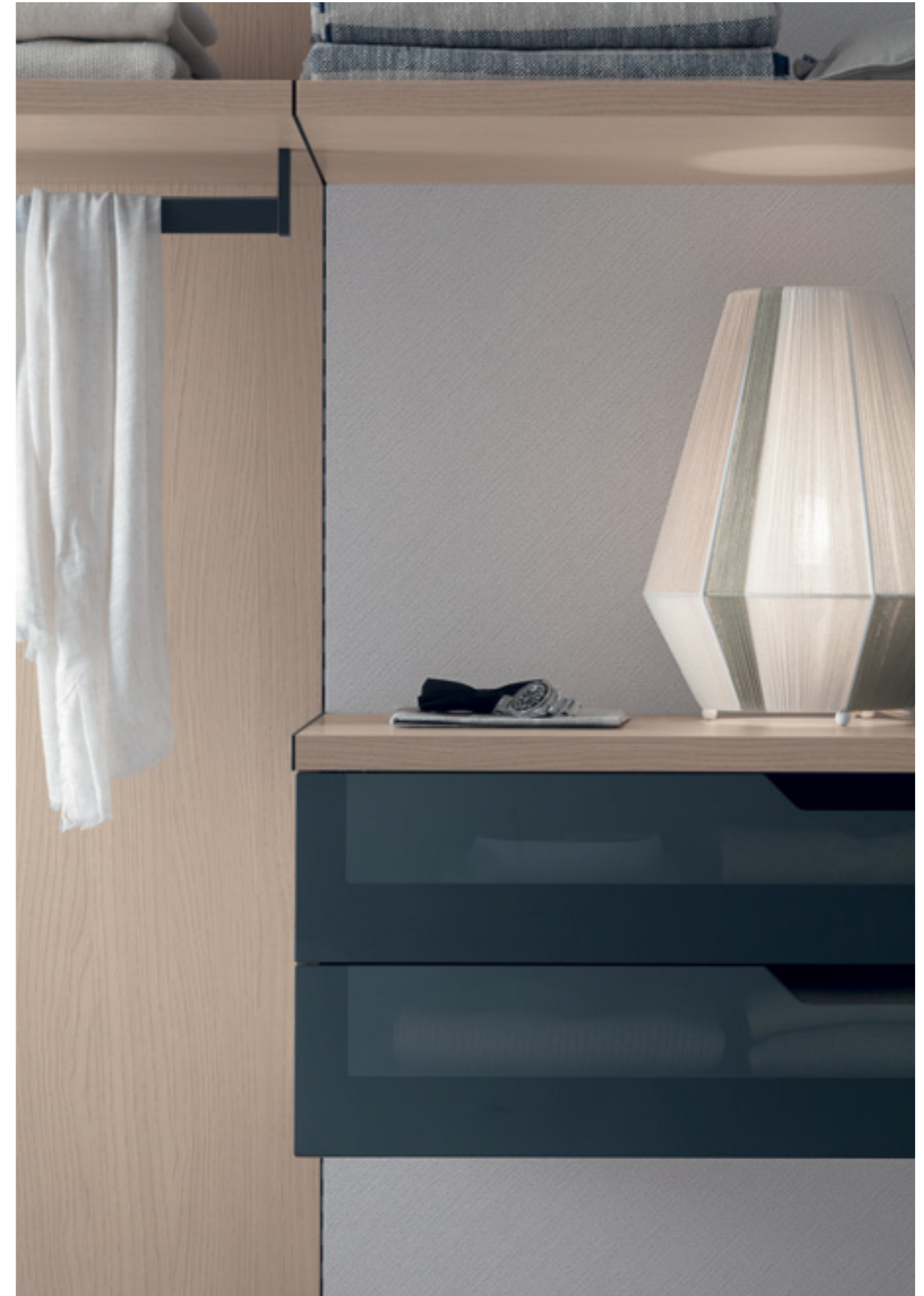

The walk-in wardrobe consists of internal fittings that help to keep things tidy and optimise space. Unlike a traditional wardrobe, everything here is visible, therefore alongside functionality, aesthetic appeal also plays a role: the drawer unit with smoked glass fronts gives the furniture a lighter stylish look.



Pratico permette di progettare soluzioni angolari che sfruttano tutto lo spazio a disposizione e, allo stesso tempo, hanno una grande resa estetica. La boiserie chiara in materico canvas da un lato, e in materico opaco basalto dall'altro, differenziano le zone della cabina e creano un piacevole gioco di contrasti cromatici.

Pratico lets you design corner solutions that maximise the available space while adding great aesthetic appeal. Light-coloured canvas wall panelling on one side, and textured matt basalt back panels on the other, differentiate the areas of the walk-in wardrobe, creating an attractive interplay of colours.





La cabina può essere attrezzata a seconda delle esigenze personali di ordine e organizzazione con una serie di accessori. Cassettiere e ripiani in materico rovere carbone si abbinano a ripiani estraibili in metallo antracite per dare all'intera struttura un look ricercato dalle tonalità scure.

The walk-in wardrobe can be fitted with a range of accessories for tidiness and organisation depending on personal needs. Textured coal oak drawer units and shelves are combined with anthracite metal pull-out shelves, giving the entire structure a sophisticated look in dark shades.



PRATICO SYSTEM + GRAPHIC

La boiserie Pratico può essere personalizzata con diverse grafiche stampate: da funzionale, la cabina armadio diventa anche estremamente decorativa. Puoi creare il tuo stile non solo scegliendo l'outfit da indossare ogni giorno, ma anche scegliendo lo sfondo della cabina armadio.

Pratico wall panelling can be customised with various printed graphics: the functional walk-in wardrobe also becomes extremely decorative. You can create your own style not only by choosing the outfit to wear every day, but also by choosing the background of the walk-in wardrobe.



Foglie, fiori, nuvole e paesaggi fanno da sfondo agli abiti e diventano come una carta da parati sulla parete. Scegli la scenografia che meglio ti rappresenta, lasciati conquistare dalle sue suggestioni visive e crea il tuo habitat ideale da vivere ogni giorno.

Leaves, flowers, clouds and landscapes create a backdrop for clothes and : look like wallpaper on the wall. Choose the background that best represents you, be captivated by its visual appeal and create your ideal habitat to live in every day.



1010



1011



1040



1041



1020



1021



1050



1051



1030



1031



1060



1061

Righe, geometrie, texture e sfumature creano sulla parete originali effetti decorativi. La cabina armadio è una stanza in cui stile e funzionalità si incontrano quotidianamente e convivono in perfetta armonia.

Stripes, patterns, textures and shades create original decorative effects on the wall. The walk-in wardrobe is a room where style and functionality are combined every day and coexist in perfect harmony.



1070

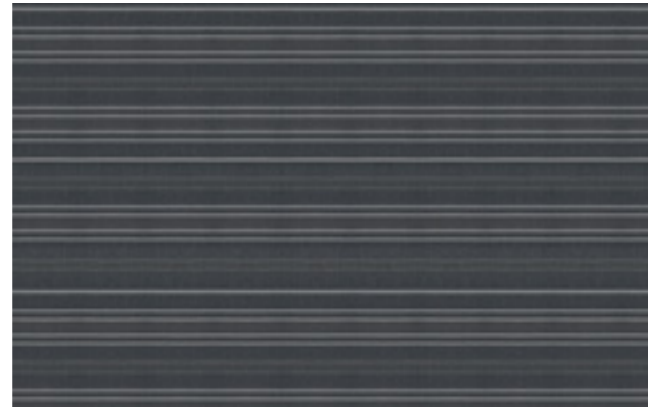

1071

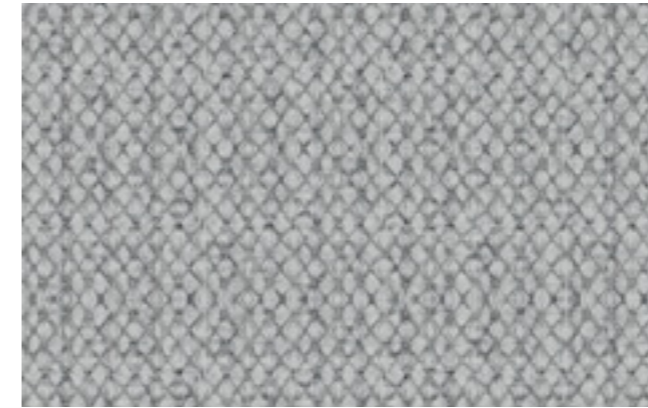

1100



1101



1080



1081



1102



1103



1090



1091

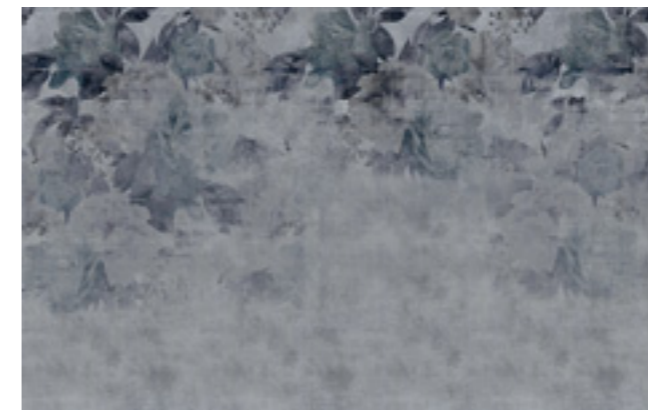

1104

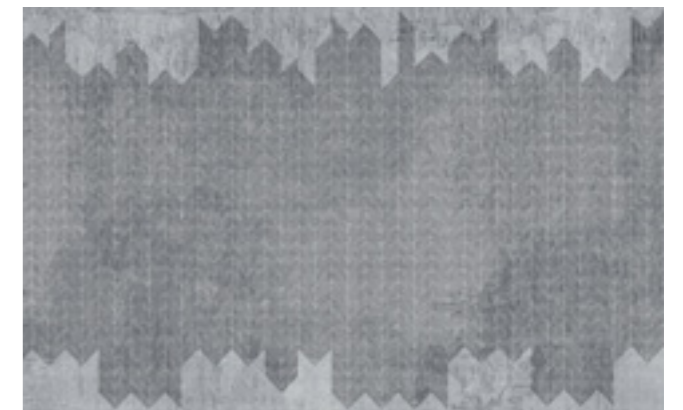

1105

PRATICO SYSTEM

INFORMAZIONI TECNICHE TECHNICAL INFORMATION

Pannelli di fondo, disponibili in diverse altezze e larghezze, predisposti per il fissaggio di una serie di attrezzature.

Back panels, available in different heights and widths, are designed for attaching a range of internal fittings.

Finiture staffe e accessori Finishes of brackets and accessories



Gris

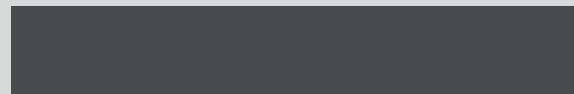

Antracite / Anthracite



Modularità / Modularity

LARGHEZZA E PROFONDITÀ WIDTHS AND DEPTHS

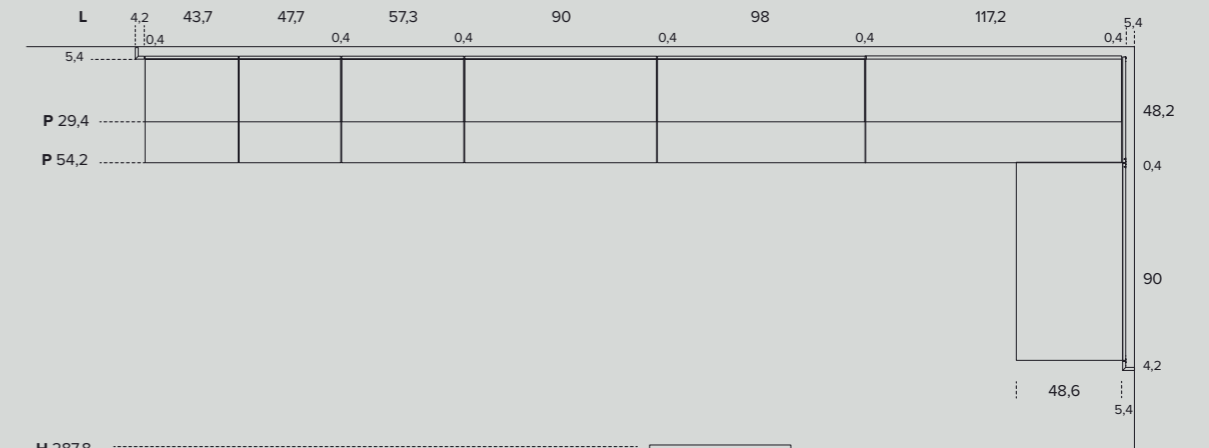

ALTEZZE HEIGHTS

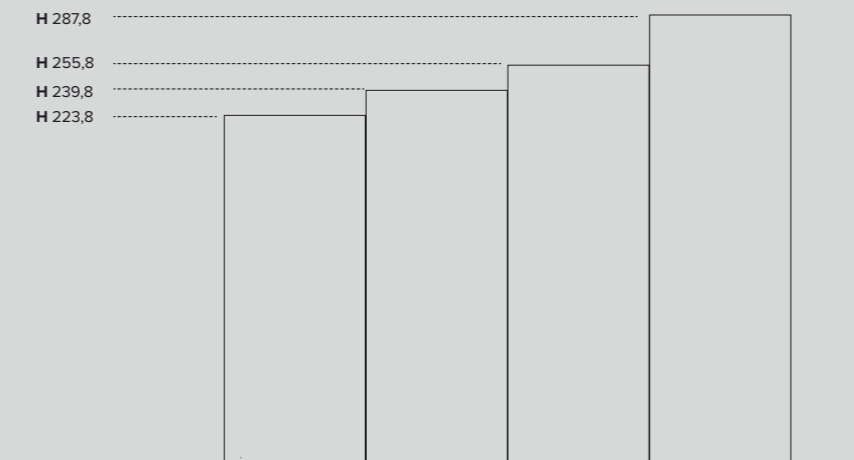

Finiture boiserie e attrezzature_ Finishes of wall panelling and fittings

MT 1/ONE



Canvas

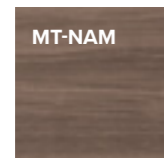

Noce ambr
Amber walnut



Rovere sabbia
Sand oak

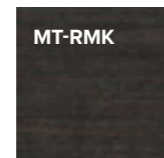

Rovere moka
Mocha oak

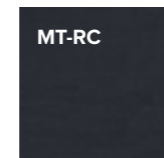

Rovere carbone
Coal oak

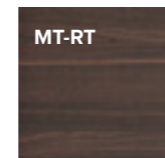

Rovere termocotto
Heat-treated oak



Frassino oriente
Eastern ash

MT PREMIUM ESSENZA / WOOD

MT PREMIUM NODATO / KNOTTED



Nodato chiaro
Light knotted

MT PREMIUM CEMENTO / CEMENT

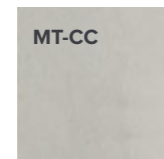

Cemento chiaro
Light cement

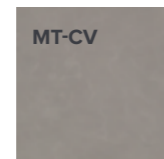

Cemento cava
Cava cement

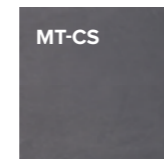

Cemento scuro
Dark cement

MT PREMIUM TEXTURE / TEXTURED

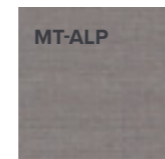

Alpaca

MT PREMIUM OPACO / MATT

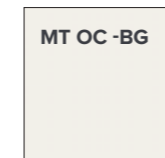

Bianco gesso
Chalk white



Madreperla
Mother-of-pearl



Arena



Basalto
Basalt

LACCATI OPACHI / MATT LACQUERS

Campioni laccati a campionario / Our lacquer colour options



PRATICO SYSTEM ATTREZZATURE

Pratico System - Internal fittings

Per essere funzionale, facile da tenere in ordine e ordinata alla vista, la cabina armadio deve essere configurata in modo da soddisfare tutte le esigenze. Cassettiere a terra o sospese, ripiani fissi o estraibili dotati di vari accessori, raster e altre attrezzature utili sono fondamentali per organizzare al meglio il contenuto.

To be functional, easy to keep tidy and visually neat, a walk-in wardrobe needs to be configured to meet all requirements. Floor-standing or wall-hung drawer units, fixed or pull-out shelves with various accessories, shelving units and other useful internal fittings are essential for organising contents as efficiently as possible.

CASSETTIERE A TERRA VETRO / FLOOR-STANDING GLASS-FRONTED DRAWER UNITS



2 cassetti / drawers
L 43,7 - 47,7 - 57,3 - 90 - 98 - 117,2 cm



3 cassetti / drawers
L 43,7 - 47,7 - 57,3 - 90 - 98 - 117,2 cm



4 cassetti / drawers
L 43,7 - 47,7 - 57,3 - 90 - 98 - 117,2 cm



5 cassetti / drawers
L 43,7 - 47,7 - 57,3 - 90 - 98 - 117,2 cm



6 cassetti / drawers
L 43,7 - 47,7 - 57,3 - 90 - 98 - 117,2 cm

CASSETTIERE SOSPESSE VETRO / WALL-HUNG GLASS-FRONTED DRAWER UNITS



1 cassetto / drawer
L 43,7 - 47,7 - 57,3 - 90 - 98 - 117,2 cm



2 cassetti / drawers
L 43,7 - 47,7 - 57,3 - 90 - 98 - 117,2 cm

CASSETTIERE A TERRA CON GOLA / FLOOR-STANDING DRAWER UNITS WITH GRIP RECESSES



2 cassetti / drawers
L 43,7 - 47,7 - 57,3 - 90 - 98 - 117,2 cm



1 cestone / deep drawer
L 43,7 - 47,7 - 57,3 - 90 - 98 - 117,2 cm



3 cassetti / drawers
L 43,7 - 47,7 - 57,3 - 90 - 98 - 117,2 cm



2 cestoni e 1 cassetto / 2 deep drawers and 1 drawer
L 43,7 - 47,7 - 57,3 - 90 - 98 - 117,2 cm



6 cassetti / drawers
L 43,7 - 47,7 - 57,3 - 90 - 98 - 117,2 cm



1 cestone e 4 cassetti / 1 deep drawer and 4 drawers
L 43,7 - 47,7 - 57,3 - 90 - 98 - 117,2 cm



1 cestone e 1 cassetto / 1 deep drawer and 1 drawer
L 43,7 - 47,7 - 57,3 - 90 - 98 - 117,2 cm



4 cassetti / drawers
L 43,7 - 47,7 - 57,3 - 90 - 98 - 117,2 cm

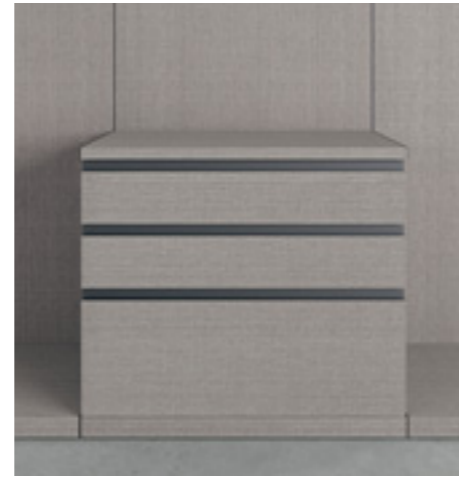

1 cestone e 2 cassetti / 1 deep drawer and 2 drawers
L 43,7 - 47,7 - 57,3 - 90 - 98 - 117,2 cm



2 cestoni e 2 cassetti / 2 deep drawers and 2 drawers
L 43,7 - 47,7 - 57,3 - 90 - 98 - 117,2 cm



3 cestoni / deep drawers
L 43,7 - 47,7 - 57,3 - 90 - 98 - 117,2 cm



2 cestoni / deep drawers
L 43,7 - 47,7 - 57,3 - 90 - 98 - 117,2 cm

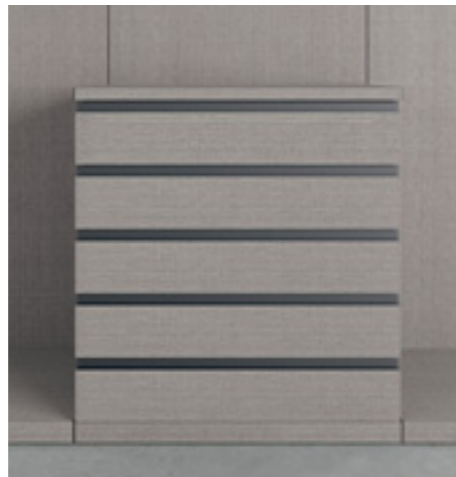

5 cassetti / drawers
L 43,7 - 47,7 - 57,3 - 90 - 98 - 117,2 cm



1 cestone e 3 cassetti / 1 deep drawer and 3 drawers
L 43,7 - 47,7 - 57,3 - 90 - 98 - 117,2 cm

CASSETTIERE SOSPESA CON GOLA / WALL-HUNG DRAWER UNITS WITH GRIP RECESSES



1 cassetto / drawer
L 43,7 - 47,7 - 57,3 - 90 - 98 - 117,2 cm



2 cassetti / drawers
L 43,7 - 47,7 - 57,3 - 90 - 98 - 117,2 cm

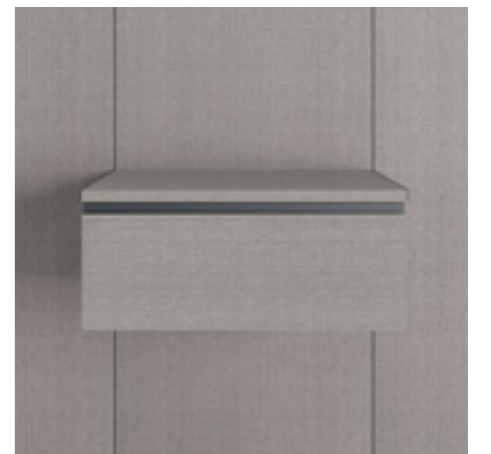

1 cestone / deep drawer
L 43,7 - 47,7 - 57,3 - 90 - 98 - 117,2 cm

CASSETTIERE A TERRA CON MANIGLIA / FLOOR-STANDING DRAWER UNITS WITH HANDLES



2 cassetti / drawers
L 43,7 - 47,7 - 57,3 - 90 - 98 - 117,2 cm



1 cestone / deep drawer
L 43,7 - 47,7 - 57,3 - 90 - 98 - 117,2 cm

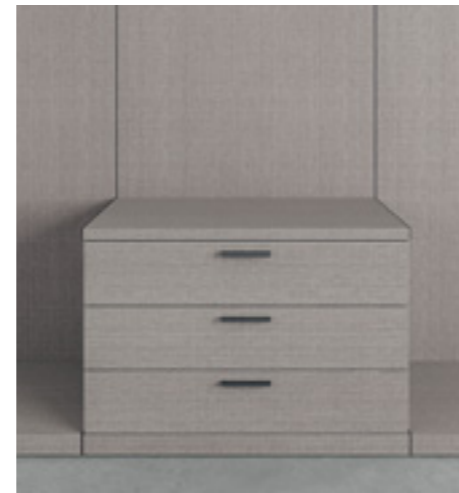

3 cassetti / drawers
L 43,7 - 47,7 - 57,3 - 90 - 98 - 117,2 cm

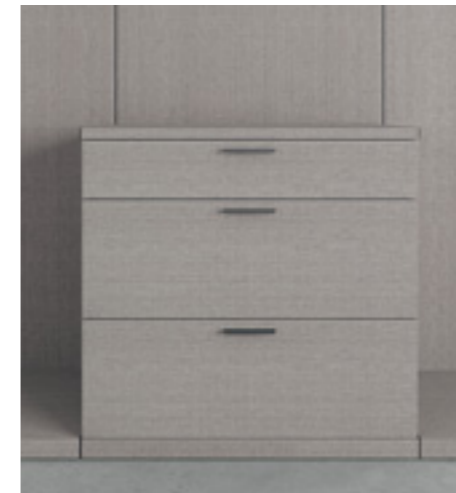

2 cestoni e 2 cassetti / 2 deep drawers and 2 drawers
L 43,7 - 47,7 - 57,3 - 90 - 98 - 117,2 cm



6 cassetti / drawers
L 43,7 - 47,7 - 57,3 - 90 - 98 - 117,2 cm



1 cestone e 4 cassetti / 1 deep drawer and 4 drawers
L 43,7 - 47,7 - 57,3 - 90 - 98 - 117,2 cm

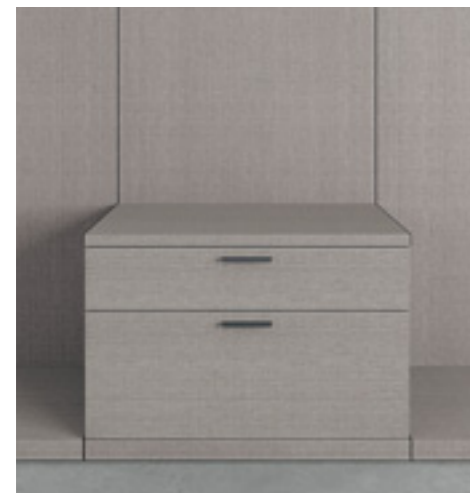

1 cestone e 1 cassetto / 1 cestone e 1 cassetto
L 43,7 - 47,7 - 57,3 - 90 - 98 - 117,2 cm

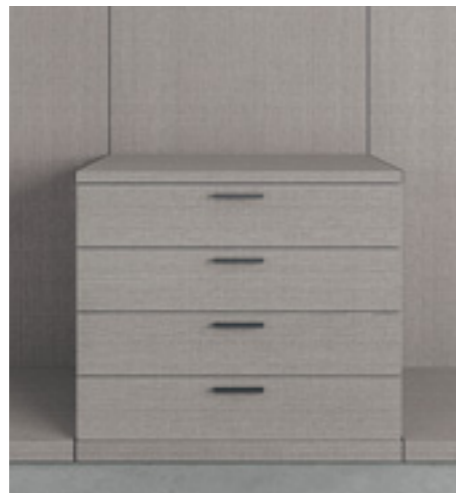

4 cassetti / cassetti
L 43,7 - 47,7 - 57,3 - 90 - 98 - 117,2 cm

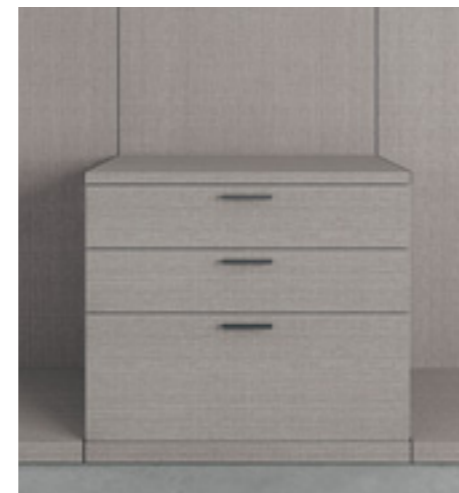

1 cestone e 2 cassetti / 1 deep drawer and 2 drawers
L 43,7 - 47,7 - 57,3 - 90 - 98 - 117,2 cm



2 cestoni e 2 cassetti / 2 deep drawers and 2 drawers
L 43,7 - 47,7 - 57,3 - 90 - 98 - 117,2 cm



3 cestoni / deep drawers
L 43,7 - 47,7 - 57,3 - 90 - 98 - 117,2 cm

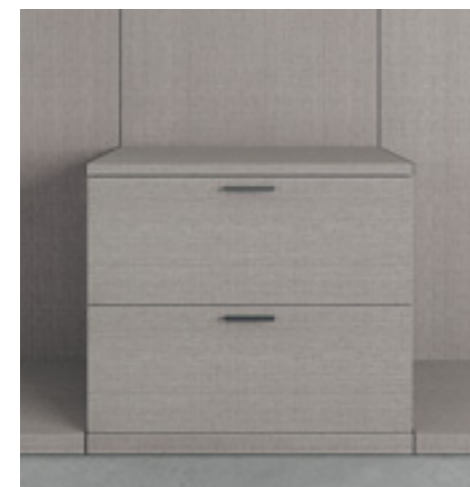

2 cestoni / deep drawers
L 43,7 - 47,7 - 57,3 - 90 - 98 - 117,2 cm

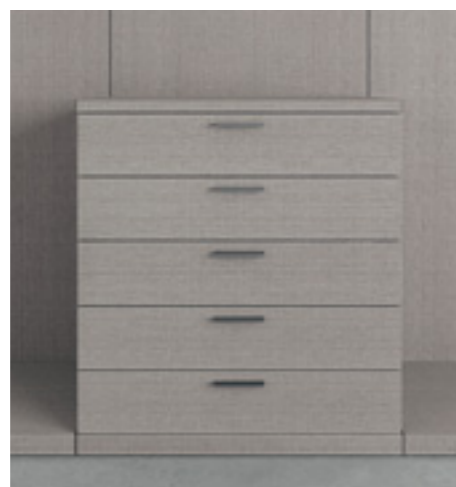

5 cassetti / drawers
L 43,7 - 47,7 - 57,3 - 90 - 98 - 117,2 cm



1 cestone e 3 cassetti / 1 deep drawer and 3 drawers
L 43,7 - 47,7 - 57,3 - 90 - 98 - 117,2 cm

CASSETTIERE SOSPESA CON MANIGLIA / WALL-HUNG DRAWER UNITS WITH HANDLES



1 cassetto / drawer
L 43,7 - 47,7 - 57,3 - 90 - 98 - 117,2 cm



2 cassetti / drawers
L 43,7 - 47,7 - 57,3 - 90 - 98 - 117,2 cm

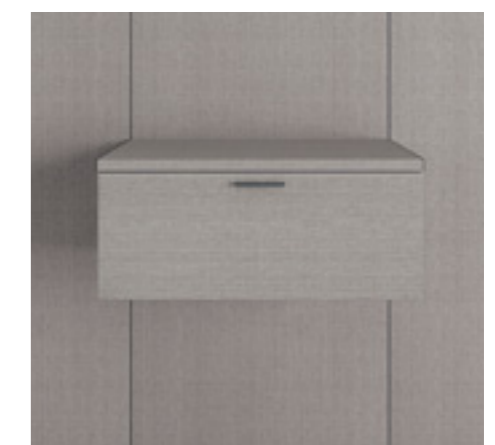

1 cestone / deep drawer
L 43,7 - 47,7 - 57,3 - 90 - 98 - 117,2 cm

ESTRAIBILE UN VANO / SINGLE PULL-OUTS



Porta pantaloni / trouser-rack
L 43,7 - 47,7 - 57,3 - 90 - 98 - 117,2 cm



Porta scarpe / shoe-rack
L 43,7 - 47,7 - 57,3 - 90 - 98 - 117,2 cm



Ripiano in vetro / glass shelf
L 43,7 - 47,7 - 57,3 - 90 - 98 - 117,2 cm

RIPIANI / SHELVES



Ripiano p.29,4 cm / shelf d.29.4 cm
L 43,7 - 47,7 - 57,3 - 90 - 98 - 117,2 cm



Ripiano p.48,6 cm / shelf d.48.6 cm
L 43,7 - 47,7 - 57,3 - 90 - 98 - 117,2 cm



Piolino estraibile appendi gruccia per ripiano
pull-out coat hanger peg for shelf

ESTRAIBILE DUE VANI / DOUBLE PULL-OUTS



Porta pantaloni e ripiano in vetro
Trouser-rack and glass shelf
L 43,7 - 47,7 - 57,3 - 90 - 98 - 117,2 cm



Porta scarpe e ripiano in vetro /
Shoe-rack and glass shelf
L 43,7 - 47,7 - 57,3 - 90 - 98 - 117,2 cm



2 ripiani vetro / 2 glass shelves
L 43,7 - 47,7 - 57,3 - 90 - 98 - 117,2 cm



Ripiano inclinato porta scarpe
Slanting shelf for shoes
L 43,7 - 47,7 - 57,3 - 90 - 98 - 117,2 cm



Tubo appendiabiti per ripiano
Hanging rail for shelf
L 43,7 - 47,7 - 57,3 - 90 - 98 - 117,2 cm



LUCE LED / LED LIGHT

Luce led per ripiano / led light for shelf
L 43,7 - 47,7 - 57,3 - 90 - 98 - 117,2 cm

RASTER / RASTER SHELVING UNITS



Raster / raster shelving unit
L 90 - 98 cm



Raster / raster shelving units
L 117,2 cm

Raster disponibile anche in appoggio
Raster units are also available in the sit-on version

ACCESSORI / ACCESSORIES



Servetto / pull-down rail
L 90 - 98 - 117,2 cm



Specchio / mirror
L 31 - H 150 cm

DOXA SYSTEM

Doxa è una cabina armadio composta da moduli a giorno, fianchi e divisori tra i quali è possibile inserire cassetti, ripiani, accessori e attrezzature. Il suo carattere distintivo è il fianco con profondità ridotta che non copre tutta la profondità della cabina e la rende visivamente leggera.

Doxa is a walk-in wardrobe consisting of open modules, side panels and partitions, between which drawers, shelves, accessories and internal fittings can be inserted. Its distinctive feature is the reduced depth of side panels, which do not cover the entire depth of the walk-in wardrobe, thus making it visually light.





DOXA COMP_ DO202
L /W 375 P/D 37,8/59,5 H 255,5 CM

Moduli a giorno materico rovere carbone.
Attrezzature materico rovere carbone,
laccato opaco onice 167.
Accessori in metallo antracite.

Textured coal oak open modules.
Textured coal oak and matt onyx 167
lacquered fittings.
Anthracite metal accessories.



DOXA COMP_ DO201
L /W 375 P/D 37,8/59,5 H 255,5 CM

Moduli a giorno materico rovere carbone.
Attrezzature materico rovere carbone,
laccato opaco onice 167 e mirto 165.
Accessori in metallo antracite.

Textured coal oak open modules.
Textured coal oak, matt onyx 167
and myrtle 165 lacquered fittings.
Anthracite metal accessories.









Doxa è disponibile con base sporgente o a filo di fianchi e divisori: nel primo caso si amplia la superficie utile per appoggiare le cassettiere, nel secondo caso si creano vani a giorno e si riduce l'ingombro, aspetto da considerare se la cabina è posizionata in una zona di passaggio.

Doxa is available with a base that is projecting or flush with side panels and partitions: the former has a larger surface area for placing drawers, whereas the latter allows open compartments to be created and reduces overall dimensions. This aspect should be considered if the walk-in wardrobe is situated where you pass by.





DOXA COMP_ DO204
L /W 450,5/310,8 P/D 37,8/59,5 H 255,5 CM

Moduli a giorno materico alpaca,
attrezzature materico noce ambra.
Accessori in metallo antracite.

Textured alpaca open modules,
textured amber walnut fittings.
Anthracite metal accessories.





Moduli a giorno in materico alpaca sono abbinati alle attrezzature in materico noce ambra e a ripiani estraibili in vetro trasparente. Una combinazione di materiali e accessori perfetta per dare forma a una cabina personalizzata e in linea con le proprie esigenze estetiche e funzionali.

Textured alpaca open modules are paired with textured amber walnut fittings and transparent glass pull-out shelves. A perfect combination of materials and accessories designed to create a customised walk-in wardrobe in line with one's own aesthetic and functional requirements.



DOXA SYSTEM

INFORMAZIONI TECNICHE TECHNICAL INFORMATION

Schiene, fianchi e divisori disponibili in diverse altezze e larghezze con predisposizione per l'inserimento di attrezzature. Cappello e pedana disponibili in due diverse profondità.

Back panels, side panels and dividers are available in various heights and widths and are all designed to accommodate fittings. The top panel and baseboard are available in two different depths

Accessori in metallo disponibili in:
Metal accessories available in:



Gris

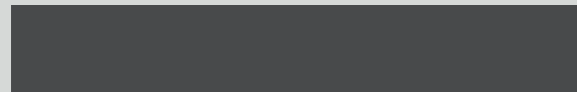

Antracite / Anthracite



Modularità / Modularity

LARGHEZZA E PROFONDITÀ WIDTHS AND DEPTHS

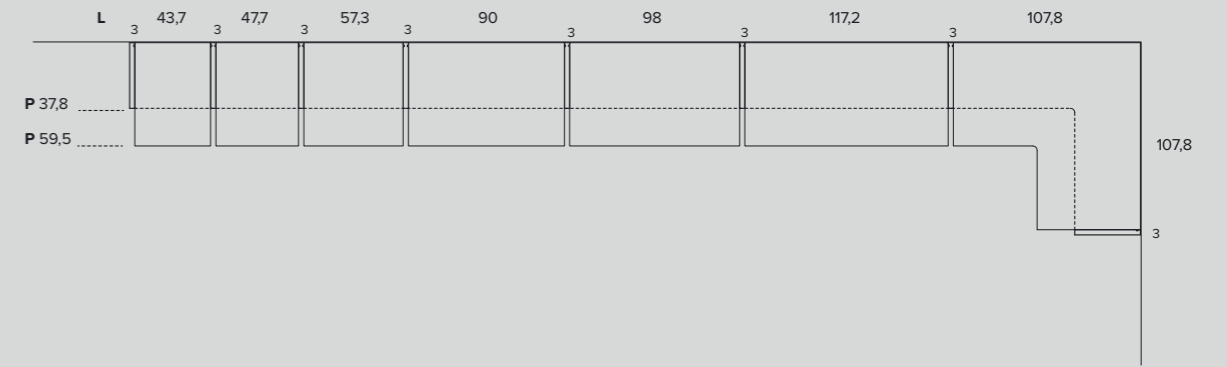

ALTEZZE HEIGHTS

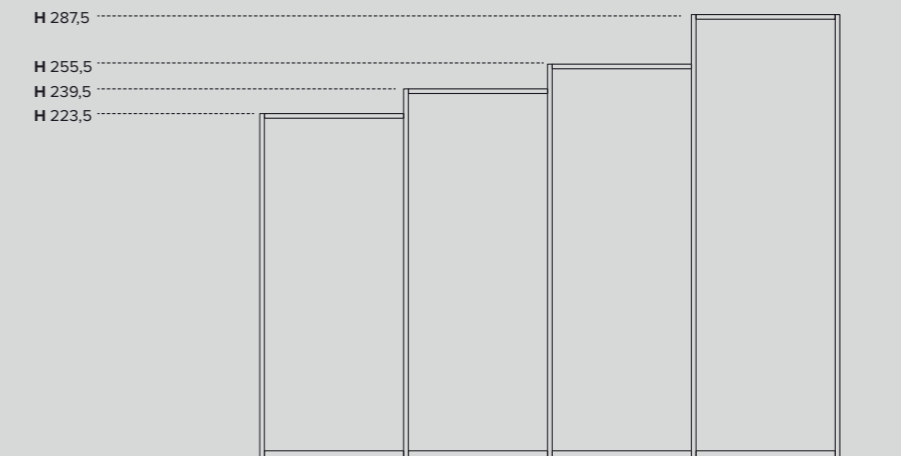

Finiture scocca e attrezzature_ Finishes for carcasses and fittings

MT 1/ONE



Canvas

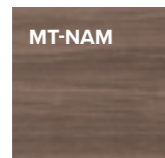

Noce ambra
Amber walnut

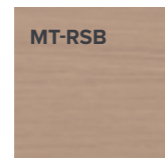

Rovere sabbia
Sand oak

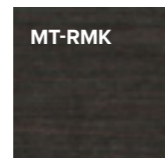

Rovere moka
Mocha oak

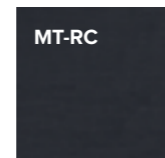

Rovere carbone
Coal oak

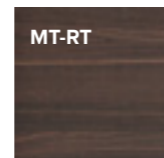

Rovere termocotto
Heat-treated oak



Frassino orientale
Eastern ash

MT PREMIUM ESSENZA / WOOD

MT PREMIUM NODATO/ KNOTTED



Nodato chiaro
Light knotted

MT PREMIUM CEMENTO / CEMENT

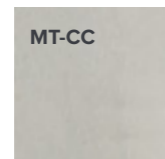

Cemento chiaro
Light cement

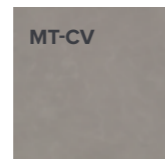

Cemento cava
Cava cement

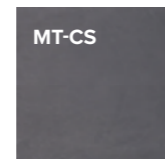

Cemento scuro
Dark cement

MT PREMIUM TEXTURE / TEXTURED

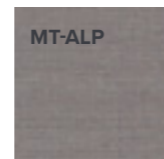

Alpaca

MT PREMIUM OPACO / MATT

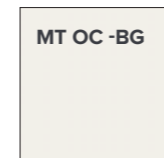

Bianco gesso
Chalk white



Madreperla
Mother-of-pearl

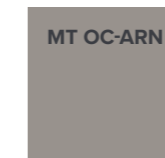

Arena



Basalto
Basalt

LACCATI OPACHI / MATT LACQUERS

Campioni laccati a campionario / Our lacquer colour options



DOXA SYSTEM ATTREZZATURE

Doxa System - Internal fittings

In una cabina armadio stile e funzionalità devono andare di pari passo. Per questo è possibile attrezzare lo spazio con cassettiere a terra o sospese, ripiani fissi o estraibili dotati di vari accessori, raster e altre attrezzature che, oltre a organizzare abiti e accessori, valorizzano l'estetica di ogni configurazione.

In a walk-in wardrobe, style and functionality must go hand in hand. The space can therefore be fitted with floor-standing or wall-hung drawers, fixed or pull-out shelves with various accessories, racks and other internal fittings, which not only organise clothes and accessories but also enhance the aesthetic look of each layout.

CASSETTIERE A TERRA VETRO / FLOOR-STANDING GLASS-FRONTED DRAWER UNITS



2 cassetti / drawers
L 43,7 - 47,7 - 57,3 - 90 - 98 - 117,2 cm



3 cassetti / drawers
L 43,7 - 47,7 - 57,3 - 90 - 98 - 117,2 cm



4 cassetti / drawers
L 43,7 - 47,7 - 57,3 - 90 - 98 - 117,2 cm



5 cassetti / drawers
L 43,7 - 47,7 - 57,3 - 90 - 98 - 117,2 cm



6 cassetti / drawers
L 43,7 - 47,7 - 57,3 - 90 - 98 - 117,2 cm

CASSETTIERE SOPPESE VETRO / WALL-HUNG GLASS-FRONTED DRAWER UNITS

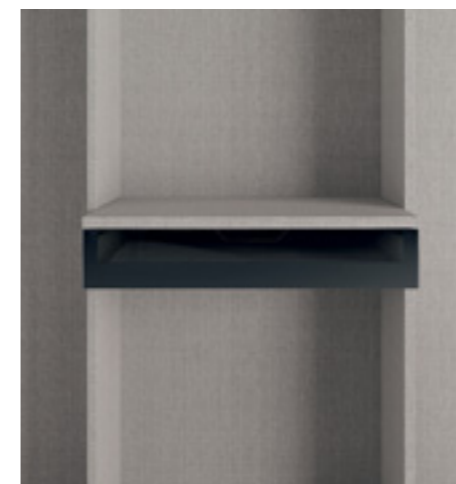

1 cassetto / drawer
L 43,7 - 47,7 - 57,3 - 90 - 98 - 117,2 cm



2 cassetti / drawers
L 43,7 - 47,7 - 57,3 - 90 - 98 - 117,2 cm

CASSETTIERE A TERRA CON GOLA / FLOOR-STANDING DRAWER UNITS WITH GRIP RECESSES

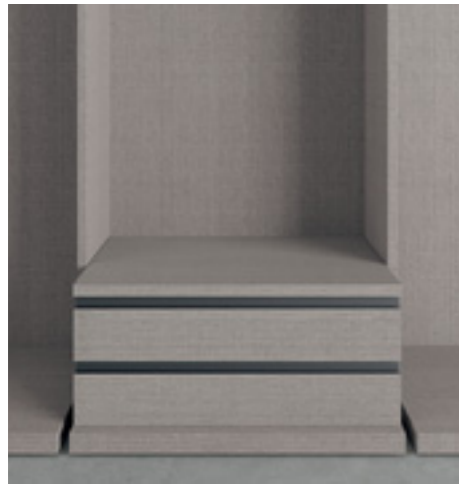

2 cassetti / drawers
L 43,7 - 47,7 - 57,3 - 90 - 98 - 117,2 cm

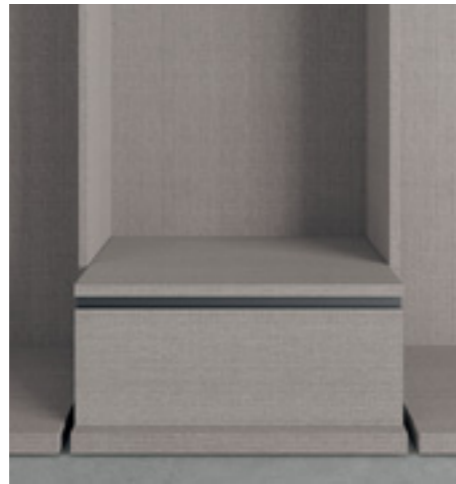

1 cestone / deep drawer
L 43,7 - 47,7 - 57,3 - 90 - 98 - 117,2 cm

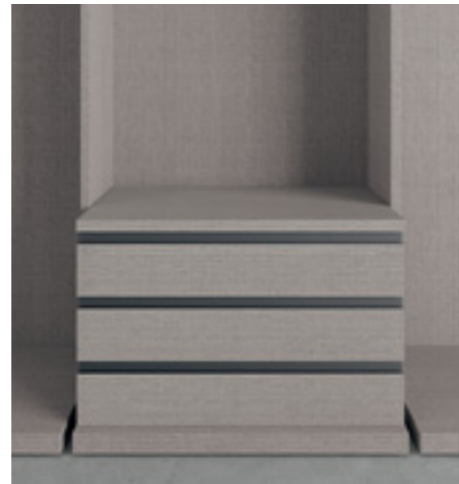

3 cassetti / drawers
L 43,7 - 47,7 - 57,3 - 90 - 98 - 117,2 cm



2 cestoni e 1 cassetto / 2 deep drawers and 1 drawer
L 43,7 - 47,7 - 57,3 - 90 - 98 - 117,2 cm



6 cassetti / drawers
L 43,7 - 47,7 - 57,3 - 90 - 98 - 117,2 cm



1 cestone e 4 cassetti / 1 deep drawer and 4 drawers
L 43,7 - 47,7 - 57,3 - 90 - 98 - 117,2 cm

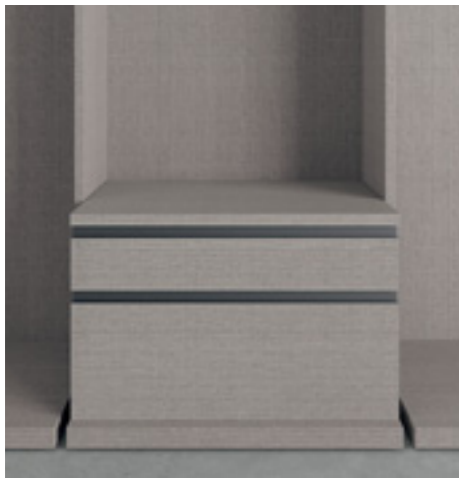

1 cestone e 1 cassetto / 1 deep drawer and 1 drawer
L 43,7 - 47,7 - 57,3 - 90 - 98 - 117,2 cm



4 cassetti / drawers
L 43,7 - 47,7 - 57,3 - 90 - 98 - 117,2 cm



1 cestone e 2 cassetti / 1 deep drawer and 2 drawers
L 43,7 - 47,7 - 57,3 - 90 - 98 - 117,2 cm



2 cestoni e 2 cassetti / 2 deep drawers and 2 drawers
L 43,7 - 47,7 - 57,3 - 90 - 98 - 117,2 cm



3 cestoni / deep drawers
L 43,7 - 47,7 - 57,3 - 90 - 98 - 117,2 cm



2 cestoni / deep drawers
L 43,7 - 47,7 - 57,3 - 90 - 98 - 117,2 cm



5 cassetti / drawers
L 43,7 - 47,7 - 57,3 - 90 - 98 - 117,2 cm



1 cestone e 3 cassetti / 1 deep drawer and 3 drawers
L 43,7 - 47,7 - 57,3 - 90 - 98 - 117,2 cm

CASSETTIERE SOSPESA CON GOLA / WALL-HUNG DRAWER UNITS WITH GRIP RECESSES

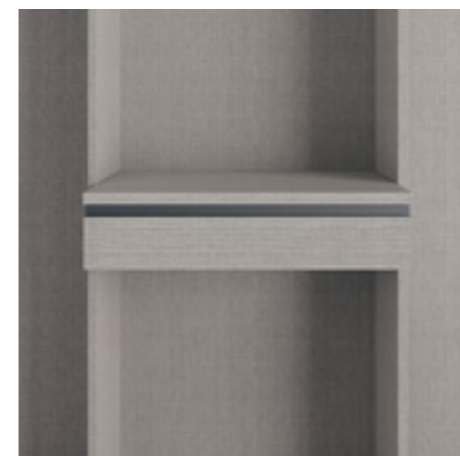

1 cassetto / drawer
L 43,7 - 47,7 - 57,3 - 90 - 98 - 117,2 cm

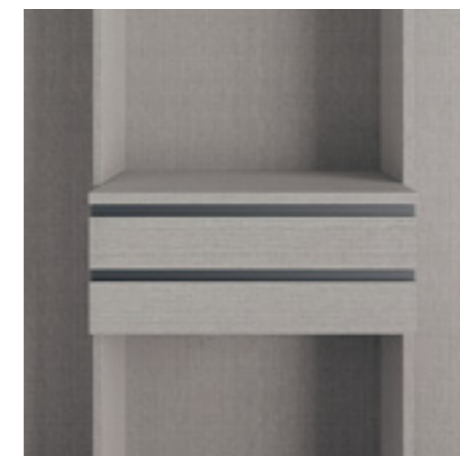

2 cassetti / drawers
L 43,7 - 47,7 - 57,3 - 90 - 98 - 117,2 cm

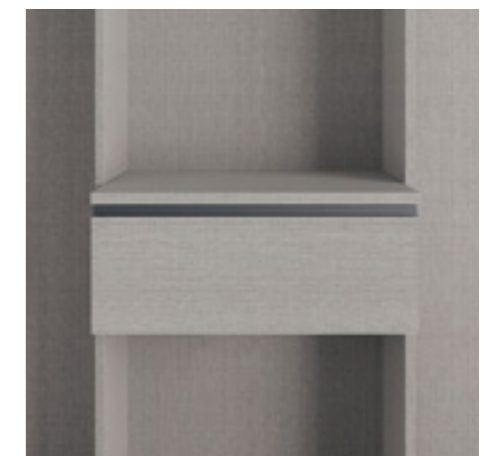

1 cestone / deep drawer
L 43,7 - 47,7 - 57,3 - 90 - 98 - 117,2 cm

CASSETTIERE A TERRA CON MANIGLIA / FLOOR-STANDING DRAWER UNITS WITH HANDLES



2 cassetti / drawers
L 43,7 - 47,7 - 57,3 - 90 - 98 - 117,2 cm



1 cestone / deep drawer
L 43,7 - 47,7 - 57,3 - 90 - 98 - 117,2 cm

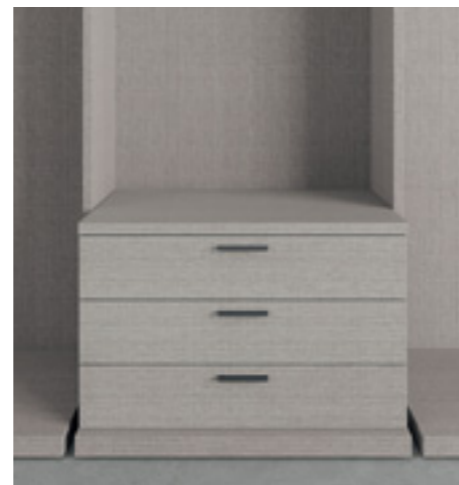

3 cassetti / drawers
L 43,7 - 47,7 - 57,3 - 90 - 98 - 117,2 cm



2 cestoni e 1 cassetto / 2 deep drawers and 1 drawer
L 43,7 - 47,7 - 57,3 - 90 - 98 - 117,2 cm



6 cassetti / drawers
L 43,7 - 47,7 - 57,3 - 90 - 98 - 117,2 cm



1 cestone e 4 cassetti / 1 deep drawer and 4 drawers
L 43,7 - 47,7 - 57,3 - 90 - 98 - 117,2 cm



1 cestone e 1 cassetto / 1 deep drawer and 1 drawer
L 43,7 - 47,7 - 57,3 - 90 - 98 - 117,2 cm



4 cassetti / drawers
L 43,7 - 47,7 - 57,3 - 90 - 98 - 117,2 cm



1 cestone e 2 cassetti / 1 deep drawer and 2 drawers
L 43,7 - 47,7 - 57,3 - 90 - 98 - 117,2 cm



2 cestoni e 2 cassetti / 2 deep drawers and 2 drawers
L 43,7 - 47,7 - 57,3 - 90 - 98 - 117,2 cm



3 cestoni / deep drawers
L 43,7 - 47,7 - 57,3 - 90 - 98 - 117,2 cm



2 cestoni / deep drawers
L 43,7 - 47,7 - 57,3 - 90 - 98 - 117,2 cm



5 cassetti / drawers
L 43,7 - 47,7 - 57,3 - 90 - 98 - 117,2 cm



1 cestone e 3 cassetti / 1 deep drawer and 3 drawers
L 43,7 - 47,7 - 57,3 - 90 - 98 - 117,2 cm

CASSETTIERE SOSPESA CON MANIGLIA / WALL-HUNG DRAWER UNITS WITH HANDLES



1 cassetto / drawer
L 43,7 - 47,7 - 57,3 - 90 - 98 - 117,2 cm



2 cassetti / drawers
L 43,7 - 47,7 - 57,3 - 90 - 98 - 117,2 cm



1 cestone / deep drawer
L 43,7 - 47,7 - 57,3 - 90 - 98 - 117,2 cm

ESTRAIBILE UN VANO / SINGLE PULL-OUTS



Porta pantaloni / trouser-rack
L 43,7 - 47,7 - 57,3 - 90 - 98 - 117,2 cm



Porta scarpe / shoe-rack
L 43,7 - 47,7 - 57,3 - 90 - 98 - 117,2 cm

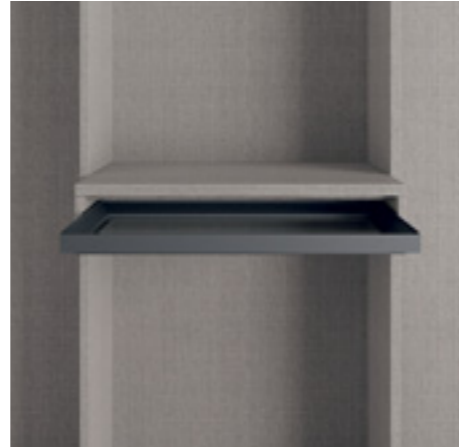

Ripiano in vetro / glass shelf
L 43,7 - 47,7 - 57,3 - 90 - 98 - 117,2 cm

RIPIANI / SHELVES

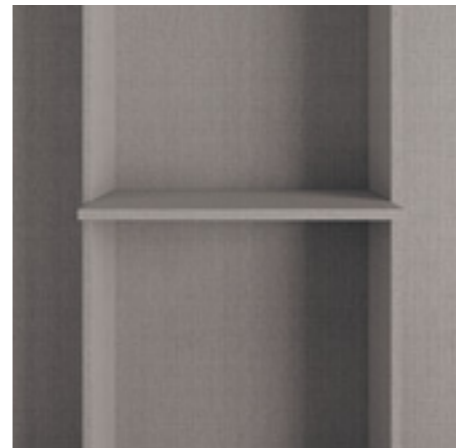

Ripiano / shelf
L 43,7 - 47,7 - 57,3 - 90 - 98 - 117,2 cm



Tubo appendiabiti per ripiano
Hanging rail for shelf
L 43,7 - 47,7 - 57,3 - 90 - 98 - 117,2 cm

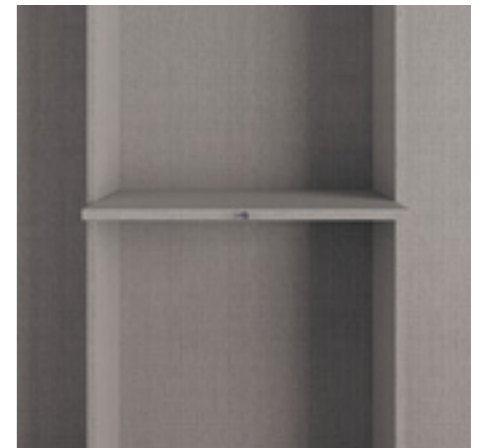

Piolino estraibile appendi gruccia per ripiano
Pull-out coat hanger peg for shelf
L 43,7 - 47,7 - 57,3 - 90 - 98 - 117,2 cm

ESTRAIBILE DUE VANI / DOUBLE PULL-OUTS



Porta pantaloni e ripiano in vetro
Trouser-rack and glass shelf
L 43,7 - 47,7 - 57,3 - 90 - 98 - 117,2 cm



Porta scarpe e ripiano in vetro
Shoe-rack and glass shelf
L 43,7 - 47,7 - 57,3 - 90 - 98 - 117,2 cm



2 ripiani vetro / 2 glass shelves
L 43,7 - 47,7 - 57,3 - 90 - 98 - 117,2 cm

ACCESSORI / ACCESSORI



Ripiano inclinato porta scarpe
Slanting shelf for shoes
L 43,7 - 47,7 - 57,3 - 90 - 98 - 117,2 cm



Servetto / pull-down rail
L 90 - 98 - 117,2 cm

RASTER / RASTER SHELVING UNITS



Raster / raster shelving unit
L 90 - 98 cm

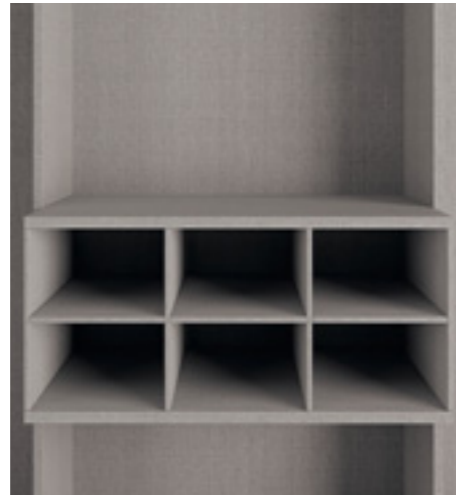

Raster / raster shelving unit
L 117,2 cm

Raster disponibile anche in appoggio
Raster units are also available in the sit-on version

LUCE LED / LED LIGHT

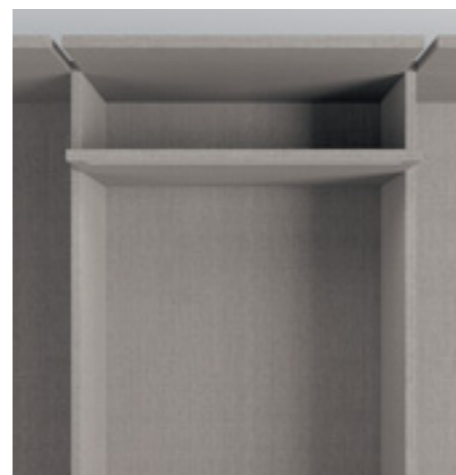

Luce led per ripiano / led light for shelf
L 43,7 - 47,7 - 57,3 - 90 - 98 - 117,2 cm

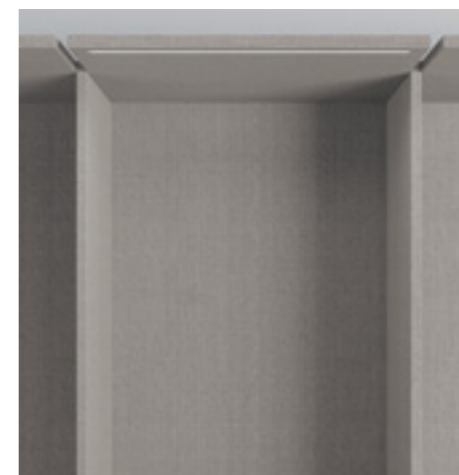

Luce led per cappello / led light for top panel
L 43,7 - 47,7 - 57,3 - 90 - 98 - 117,2 cm

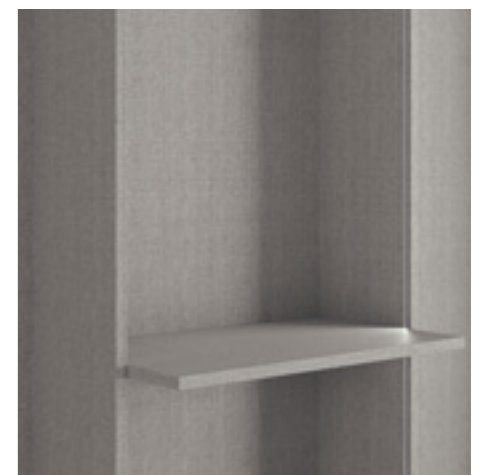

Luce led per fianco / led light for side panel
L 43,7 - 47,7 - 57,3 - 90 - 98 - 117,2 cm

LIBERTY SYSTEM

Liberty è una cabina armadio formata da telai in metallo fissati a parete e a soffitto, soluzione ideale anche per mansarde. La struttura è predisposta per accogliere cassetti, ripiani, accessori e attrezzature da posizionare e abbinare in totale libertà.

Liberty is a walk-in wardrobe comprising metal frames fixed to the wall and ceiling, an ideal solution also for attic rooms. The structure is designed to house drawers, shelves, accessories and internal fittings, which can be positioned and combined as you please.









I telai di Liberty sono disponibili in due colorazioni, gris e antracite, che si abbinano ad una serie di elementi, come cassettiere e ripiani, in diverse finiture e colori per arredare lo spazio con configurazioni personalizzate e combinazioni cromatiche originali.

Liberty frames are available in two colours, gris and anthracite. They can be combined with a range of elements, such as drawer units and shelves in various finishes and colours for furnishing the space with customised layouts and original colour combinations.





Armadio battente anta Doris.
Finitura e struttura materico alpaca.
Maniglia integrata metallo antracite.

Wardrobe with hinged Doris doors.
Textured alpaca structure.
Anthracite metal integrated handle.

LIBERTY COMP_LI302
L /W 249.5/291.8 P/D 59,5 H 255 CM
(escluso armadio / excluding the wardrobe)

Telai metallo antracite. Attrezzature materico alpaca, cassettiere laccato opaco antracite 160 con frontali in vetro.

Anthracite metal frame. Textured alpaca fittings, matt anthracite 160 drawer units with glass fronts.





Liberty può essere affiancata ad armadi per creare composizioni sia aperte che chiuse. Dal punto di vista pratico, la soluzione mista permette di soddisfare tutte le esigenze di contenimento. È possibile coordinare le finiture della cabina armadio e dell'armadiatura in modo da ottenere un'armonia cromatica.



Liberty can be combined with wardrobes to create open and closed arrangements. In practical terms, the combined solution meets all storage needs. The finishes of the walk-in wardrobe and its internal fittings can be coordinated to achieve a harmonious colour scheme.



La luce a led opzionale integrata a tutta altezza sui telai e il frontale in vetro dei cassetti alleggeriscono ulteriormente la struttura. Il minimalismo di Liberty è perfetto per chi cerca una soluzione "leggera" dal punto di vista estetico che, allo stesso tempo, sia estremamente funzionale e adattabile.

The optional full-height built-in LED light on the frames and the glass front of the drawers make the structure look even lighter. The minimalist appeal of Liberty is perfect for those looking for an aesthetically "light" solution that is also extremely functional and adaptable.







Grazie alla sua versatilità, Liberty arreda architetture particolari, come sottotetti e mansarde, con un'installazione cielo-terra dei montanti. In questo modo è possibile creare una cabina armadio su misura sfruttando tutto lo spazio utile e personalizzando la struttura anche in altezza.

With its versatility, Liberty furnishes particular architectural spaces, such as attics and lofts, with the installation of floor-to-ceiling uprights. A tailor-made walk-in wardrobe can therefore be created by exploiting all useful space and customising the structure, also in height.

LIBERTY SYSTEM

INFORMAZIONI TECNICHE TECHNICAL INFORMATION

Telai in metallo con sistema di fissaggio a due punti e predisposizione per l'inserimento di attrezzature. Altezza su misura per soffitti inclinati.

Metal frame with a two-spot fixing system, designed to accommodate fittings. Custom heights are available for slanting ceilings.

Finiture telaio e accessori Finishes of frame and accessories



Gris

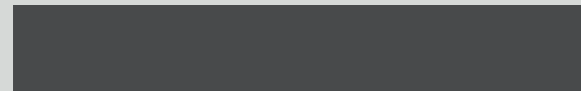

Antracite / Anthracite



Modularità / Modularity

LARGHEZZA E PROFONDITÀ / WIDTHS AND DEPTHS

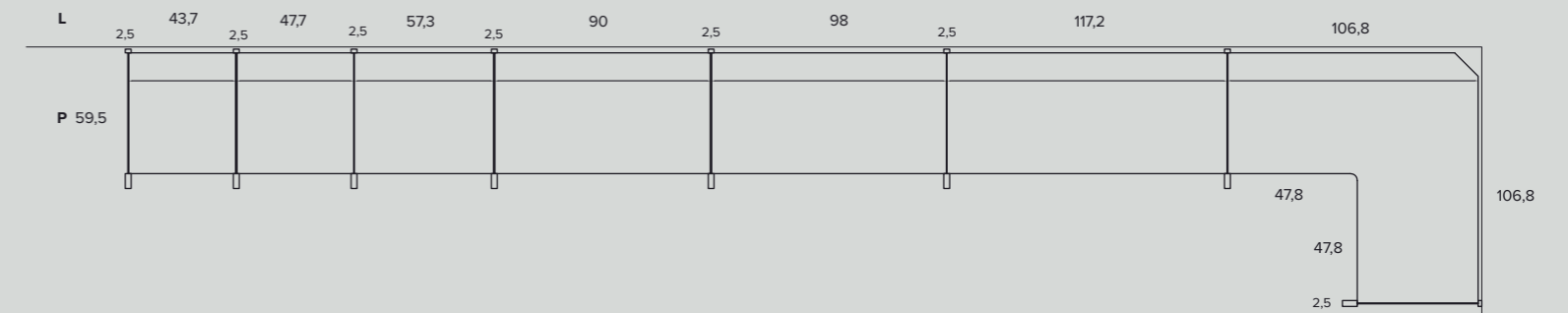

ALTEZZE HEIGHTS

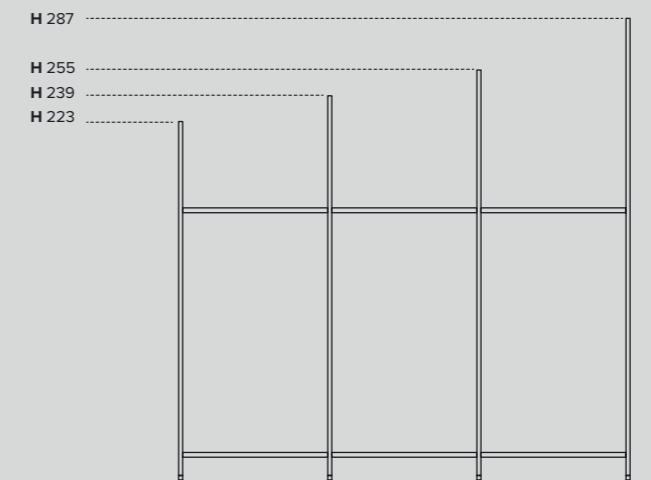

Finiture attrezzatura_Finishes of fittings

MT 1/ONE



Canvas

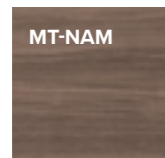

Noce ambr
Amber walnut



Rovere sabbia
Sand oak

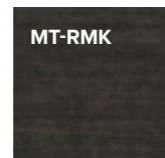

Rovere moka
Mocha oak

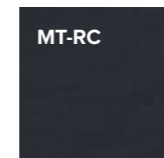

Rovere carbone
Coal oak

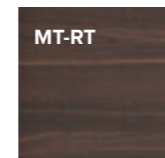

Rovere termocotto
Heat-treated oak



Frassino oriente
Eastern ash

MT PREMIUM ESSENZA / WOOD

MT PREMIUM NODATO / KNOTTED

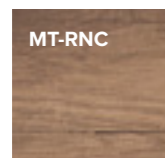

Nodato chiaro
Light knotted

MT PREMIUM CEMENTO / CEMENT

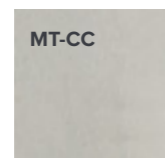

Cemento chiaro
Light cement

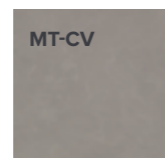

Cemento cava
Cava cement

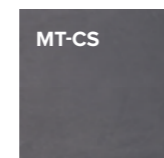

Cemento scuro
Dark cement

MT PREMIUM TEXTURE / TEXTURED

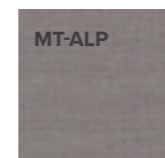

Alpaca

MT PREMIUM OPACO / MATT

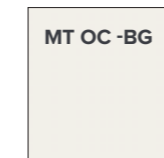

Bianco gesso
Chalk white



Madreperla
Mother-of-pearl



Arena



Basalto
Basalt

LACCATI OPACHI / MATT LACQUERS

Campioni laccati a campionario / Our lacquer colour options



LIBERTY SYSTEM ATTREZZATURE

Liberty System - Internal fittings

Cassettiere con gola o in vetro, ripiani fissi o estraibili dotati di vari accessori e luci a led integrate al montante completano la funzionalità della cabina armadio. Cappotti e abiti lunghi possono essere appesi senza stropicciarsi sul fondo, mentre camicie, pantaloni, scarpe e accessori trovano facilmente spazio e posto grazie alle attrezzature disponibili.

Drawer units with grip recesses or in glass fronts, fixed or pull-out shelves with various accessories and LED lights built into the upright complement the functionality of the walk-in wardrobe. Coats and maxi dresses can be hung without creasing at the bottom, whereas shirts, trousers, shoes and accessories can be stored easily in the wardrobe thanks to its internal fittings.

CASSETTIERE CON GOLA / DRAWER UNITS WITH GRIP RECESSES



Maniglia gola
Grip recess



1 cassetto / drawer
L 43,7 - 47,7 - 57,3 - 90 - 98 - 117,2 cm



2 cassetti / drawers
L 43,7 - 47,7 - 57,3 - 90 - 98 - 117,2 cm

CASSETTIERE IN VETRO / GLASS-FRONTED DRAWER UNITS



Maniglia frontale vetro
Handle for glass front



1 cassetto / drawer
L 43,7 - 47,7 - 57,3 - 90 - 98 - 117,2 cm



2 cassetti / drawers
L 43,7 - 47,7 - 57,3 - 90 - 98 - 117,2 cm

ESTRAIBILE UN VANO / SINGLE PULL-OUTS



Porta pantaloni / trouser-rack
L 43,7 - 47,7 - 57,3 - 90 - 98 - 117,2 cm



Porta scarpe / shoe-rack
L 43,7 - 47,7 - 57,3 - 90 - 98 - 117,2 cm



Ripiano in vetro / glass shelf
L 43,7 - 47,7 - 57,3 - 90 - 98 - 117,2 cm

RIPIANI / SHELVES



Ripiano / shelf
L 43,7 - 47,7 - 57,3 - 90 - 98 - 117,2 cm



Ripiano con tubo / shelf with hanging rail
L 43,7 - 47,7 - 57,3 - 90 - 98 - 117,2 cm



Ripiano inclinato porta scarpe / slanting shelf for shoes
L 43,7 - 47,7 - 57,3 - 90 - 98 - 117,2 cm

ESTRAIBILE DUE VANI / DOUBLE PULL-OUTS



Porta pantaloni e ripiano vetro
Trousers-rack and glass shelf
L 43,7 - 47,7 - 57,3 - 90 - 98 - 117,2 cm



Porta scarpe e ripiano vetro
Shoe-rack and glass shelf
L 43,7 - 47,7 - 57,3 - 90 - 98 - 117,2 cm



2 ripiani vetro / 2 glass shelves
L 43,7 - 47,7 - 57,3 - 90 - 98 - 117,2 cm



Ripiano con piolo / shelf with peg
L 43,7 - 47,7 - 57,3 - 90 - 98 - 117,2 cm

MONTANTE CON LUCE A LED SU FIANCO / UPRIGHT WITH SIDE LED LIGHTS



ISOLE ATTREZZATE

Accessorised island drawer units

Elementi indispensabili in ogni camera per la biancheria, i maglioni e gli accessori. Le isole attrezzate valorizzano la cabina armadio e completano la "funzione del contenere" si propongono abbinare alle cabine armadio con linee rigorose e con finiture preziose.

Essential items in every bedroom for laundry, pullovers and accessories. Accessorised island drawer units enhance the walk-in wardrobe and complement its storage function. They are available matched with walk-in wardrobes with clear-cut lines and fine finishes.



Isola attrezzata , vani a giorno in finitura materico rovere moka. Divanetto integrato. Cassetti e top in vetro fumè 601.

L /W 184,8 P/D 96,4 H 70,5 CM

Accessorised island with open compartments in a textured Mocha oak finish. Integrated seat. Smoked glass 601 drawers and top.

ISOLE ATTREZZATE

Accessorised island drawer units

Le isole attrezzate rappresentano la soluzione d'arredo perfetta per completare e valorizzare l'ambiente della zona notte dedicato al proprio guardaroba. L'elevata cura per il dettaglio le rendono un complemento d'arredo unico, in questa pagina tre diverse soluzioni.

Accessorised island drawer units are the perfect furnishing solution for complementing and enhancing the space dedicated to your wardrobe in the sleeping area. Great attention to detail makes it a unique furnishing item. Three different solutions are shown on this page.



Isola attrezzata con cassetti e vani a giorno laccato opaco rubino 172 e materico noce ambra. Top in vetro Fumè 601.

Accessorised island with drawers and open compartments in matt ruby red 172 lacquer and textured amber walnut. Top in smoked glass 601.

L /W 275,7 P/D 96,4 H 70,5 cm

Isola attrezzata un lato con cassetti e vani a giorno materico noce ambra. Top in vetro fumè 601.

Accessorised island with drawers and open compartment on one side in textured amber walnut. Smoked glass 601 top.

L /W 184,8 P/D 49,7 H 70,5 cm

Isola attrezzata vani a giorno materico noce ambra. Top e cassetti vetro fumè 601.

Accessorised island with open compartments in textured amber walnut. Smoked glass 601 drawers and top.

L /W 144,1 P/D 49,7 H 70,5 cm

SISTEMA APERTURE DOORS

Doors - Open System

A libro, scorrevole a terra o scorrevole sospesa: la cabina armadio può essere divisa dalla camera da letto attraverso tre pratici sistemi, che chiudono la stanza guardaroba e aprono nuovi spazi da organizzare.

Folding, floor-mounted sliding or top-hung sliding doors: the walk-in wardrobe can be separated from the bedroom by means of three practical systems, which close off the wardrobe room and open up new spaces to be organised.



01_ APERTURA A LIBRO
FOLDING DOORS

02_ APERTURA SCORREVOLE SOSPESA
TOP-HUNG SLIDING DOORS

03_ APERTURA SCORREVOLE A TERRA
FLOOR-MOUNTED SLIDING DOORS

01_ APERTURA A LIBRO

Folding doors

L'apertura pieghevole a libro è una pratica soluzione salvaspazio, adatta anche alle metrature contenute: le ante si ripiegano su se stesse e scorrono lateralmente lungo il binario superiore, minimizzando l'ingombro. Il profilo in alluminio brown delle ante può essere personalizzato vetri bronzo o fumè, disponibili anche nella loro versione satinata.

Folding doors are a practical, space-saving solution, also for limited spaces: the doors fold in on themselves and slide sideways along the upper track, minimising overall dimensions. The brown aluminium frame of the doors can be customised with bronze or smoked glass panels, also available in a satin finish.

BRIDGE ANTA MODELLO / MODEL DOOR

Pannello solo finitura vetro.
Glass panel only available.



LINE MANIGLIA / HANDLE

Maniglia di serie.
Standard handle.



APERTURA A LIBRO
FOLDING DOOR
COMP_D901
L /W 300 H 270 CM

Anta Bridge finitura profilo brown,
pannello in vetro fumè 601.

Bridge door with brown frame and
smoked glass 601 panel.



01_APERTURA A LIBRO

Folding doors



L'apertura pieghevole a libro può essere costituita da una o da due coppie di ante, a seconda dello spazio a disposizione. Questa soluzione permette di aprire contemporaneamente e completamente tutti i vani offrendo un accesso totale e una visuale completa della cabina armadio.

Folding doors can consist of one or two pairs of doors, depending on the available space. This solution allows all compartments to be fully opened at the same time, offering total access and a full view of the walk-in wardrobe.

CONFIGURAZIONI / CONFIGURATIONS

BINARIO 1 1-WAY TRACK

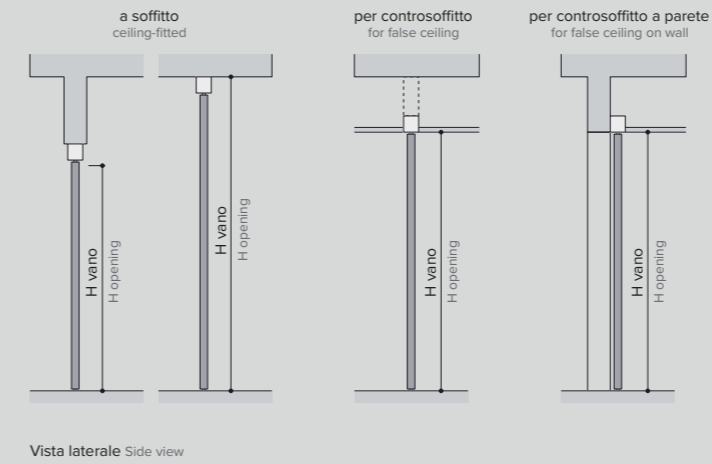

Vista laterale Side view

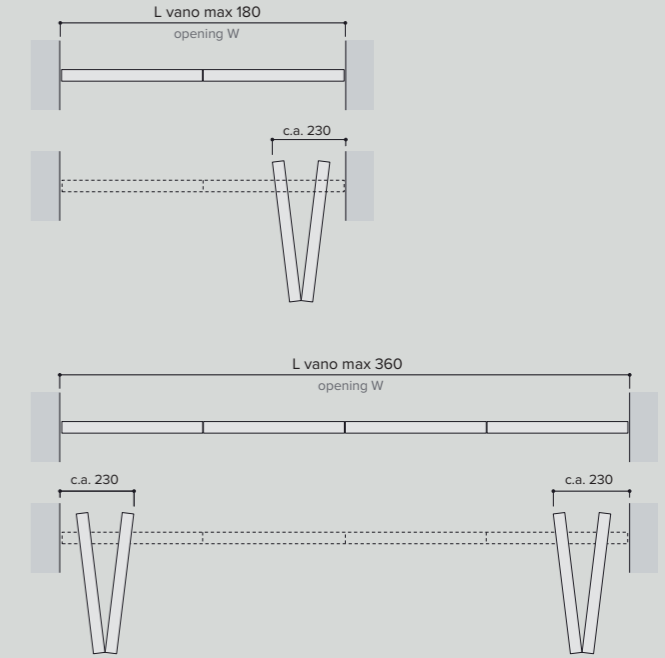

Vista in pianta Plan view

FINITURA PROFILO / FRAME FINISH



Brown

DIMENSIONE ANTA / DOOR SIZE

L. max con due ante 180	W. with two doors 180
L. max con quattro ante 360	W. with four doors 360
H. max 300	Max H. 300

FINITURA PANNELLO / PANEL FINISH

VETRI / GLASS

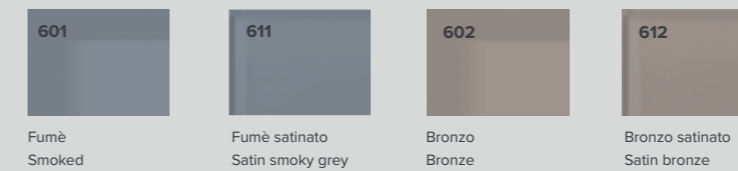

Le aperture a libro sono disponibili solo con anta Bridge disponibile solo in vetro.

Folding doors are only available in the Bridge version in glass.

02_APERTURA SCORREVOLE SOSPESA

Top-hung sliding doors

Nel sistema di apertura scorrevole sospesa le ante scorrono su un binario superiore, a una o due vie, fissato a parete, soffitto o incasso. Il profilo in alluminio delle ante, disponibile in due modelli, può essere personalizzato con pannelli in diverse finiture materiche e vetro.

In the top-hung sliding door system, the doors slide along a 1-way or 2-way upper track. Available ceiling-mounted, wall-mounted or recessed. The aluminium frame of the doors, available in two models, can be customised with panels in different textured finishes and glass.

GATE ANTA MODELLO / MODEL DOOR

Pannello finitura vetro e materico.
Glass or textured finish panel.



BRIDGE ANTA MODELLO / MODEL DOOR

Pannello solo finitura vetro.
Glass panel only available.



MONO MANIGLIA / HANDLE

Maniglia di serie per anta Bridge.
Maniglia optional per anta Gate.
Standard handle for Bridge door.
Optional handle for Gate door.



APERTURA SCORREVOLE SOSPESA
TOP-HUNG SLIDING DOOR
COMP_D902
L/W 195 H 250 CM

Anta Gate finitura profilo brown.
pannello in vetro bronzo 602.

Gate door with a brown frame,
bronze glass 602 panel.



02_APERTURA SCORREVOLE SOSPESA

Top-hung sliding doors



FINITURA PROFILO / FRAME FINISH



Brown

FINITURA PANNELLO / PANEL FINISH

MT 1/ONE



Noce ambra
Amber walnut

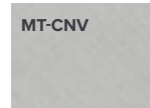

Canvas



Rovere Sabbia
Sand oak

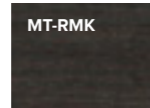

Rovere Moka
Mocha Oak

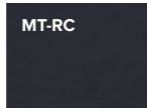

Rovere Carbone
Coal oak

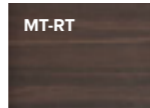

Rovere Termocotto
Heat-treated oak

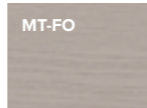

Frassino oriente
Eastern ash



Nodato chiaro
Light knotted

MT PREMIUM

ESSENZA / WOOD

MT PREMIUM

CEMENTO / CEMENT

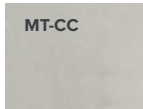

Cemento chiaro
Light cement

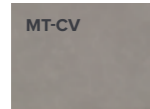

Cemento cava
Cava cement

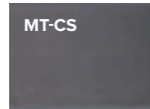

Cemento scuro
Dark cement

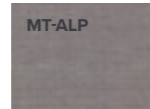

Alpaca

MT PREMIUM

TEXTURE / TEXTURED

MT PREMIUM

OPACO / MATT

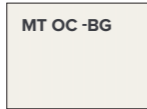

Bianco Gesso
Chalk White

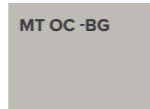

Madreperla
Mother of pearl

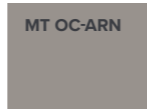

Arena



Basalto
Basalt

Anta Gate disponibile in finitura materico e vetro.
Anta Bridge disponibile solo in vetro.
The Gate door is available with a textured or glass finish.
The Bridge door is only available in glass.

DIMENSIONE ANTA / DOOR SIZE

L. max 150 (per finiture vetro)

L. max 120 (per finiture materiche)

H. max 300

Max. W. 150 (for glass finishes)

Max. W. 120 (for textured finishes)

Max H. 300

VETRI / GLASS

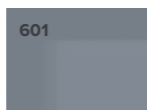

Fumè
Smoked

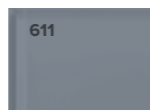

Fumè satinato
Satin smoky grey

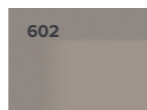

Bronzo
Bronze

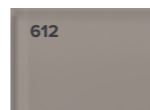

Bronzo satinato
Satin bronze

CONFIGURAZIONI / CONFIGURATIONS

BINARIO 1 VIA ESTERNO VANO 1-WAY TRACK OUTSIDE OPENING

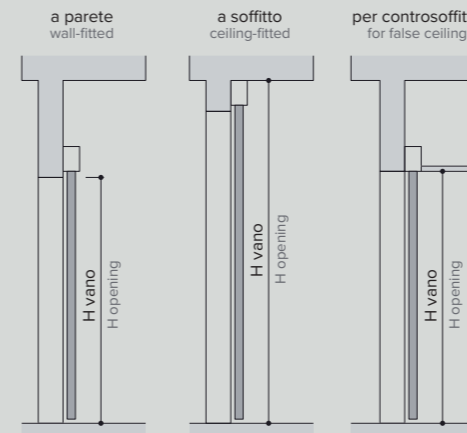

Vista laterale Side view

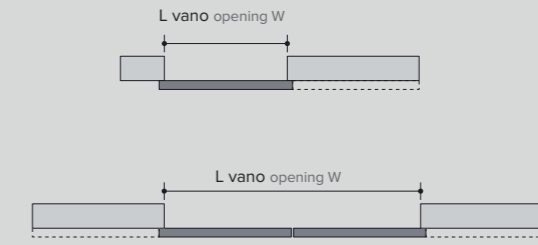

Vista in pianta Plan view

BINARIO 2 VIE ESTERNO VANO 2-WAY TRACK OUTSIDE OPENING

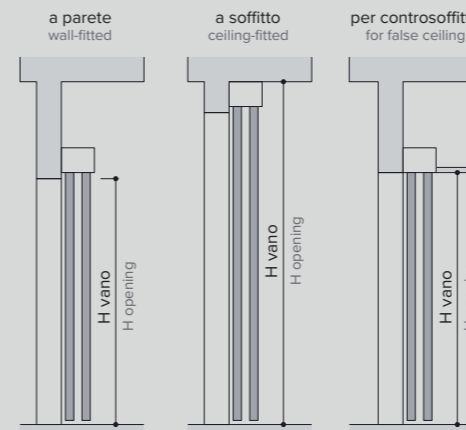

Vista laterale Side view

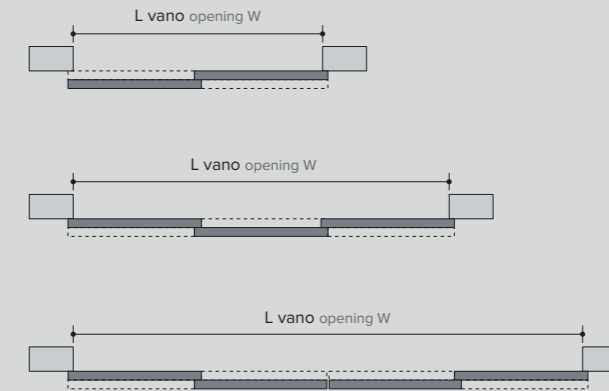

Vista in pianta Plan view

BINARIO 2 VIE INTERNO VANO 2-WAY TRACK INSIDE OPENING

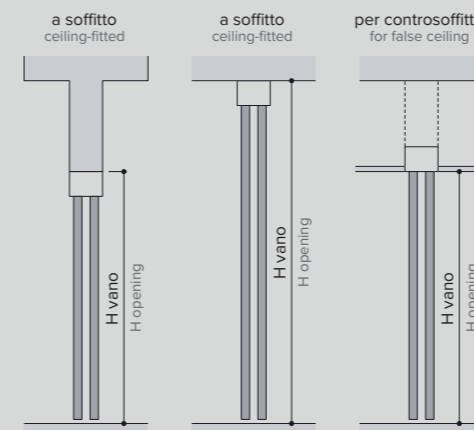

Vista laterale Side view

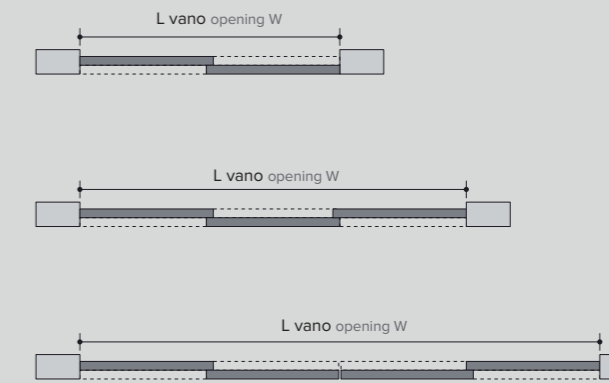

Vista in pianta Plan view

03_APERTURA SCORREVOLE A TERRA

Floor-mounted sliding doors

Il sistema scorrevole a terra è ideale per grandi aperture che necessitano di più ante. Queste scorrono su un binario superiore e un binario inferiore, a una o due vie. Il profilo in alluminio delle ante, disponibile in due modelli, può essere personalizzato con pannelli in diverse finiture materiche e vetro.

The floor-mounted sliding door system is ideal for large openings that require several doors. These slide along an upper track and a 1-way or 2-way lower track. The aluminium frame of the doors, available in two models, can be customised with panels in different textured finishes and glass.

GATE ANTA MODELLO / MODEL DOOR

Pannello finitura vetro e materico.
Glass or textured finish panel.



BRIDGE ANTA MODELLO / MODEL DOOR

Pannello solo finitura vetro.
Glass panel only available.



MONO MANIGLIA / HANDLE

Maniglia di serie per anta Bridge.
Maniglia optional per anta Gate.
Standard handle for Bridge door.
Optional handle for Gate door.



APERTURA SCORREVOLE A TERRA
FLOOR-MOUNTED SLIDING DOOR
COMP_D903
L / W 470 H 270 CM

Anta Gate finitura profilo brown.
pannello in materico alpaca.

GATE door with brown frame
and textured alpaca panel.



03_APERTURA SCORREVOLE A TERRA

Floor-mounted sliding doors



FINITURA PROFILO / FRAME FINISH



Brown

FINITURA PANNELLO / PANEL FINISH

MT 1/ONE



MT-NAM
Noce ambra
Amber walnut

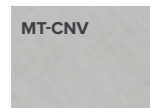

MT-CNV
Canvas



MT-RSB
Rovere Sabbia
Sand oak

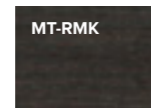

MT-RMK
Rovere Moka
Mocha Oak

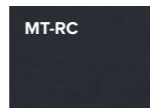

MT-RC
Rovere Carbone
Coal oak

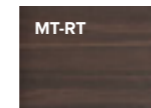

MT-RT
Rovere Termocotto
Heat-treated oak

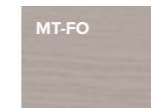

MT-FO
Frassino oriente
Eastern ash

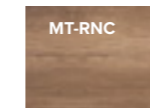

MT-RNC
Nodato chiaro
Light knotted

MT PREMIUM

ESSENZA / WOOD

MT PREMIUM

CEMENTO / CEMENT

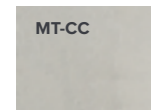

MT-CC
Cemento chiaro
Light cement

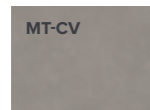

MT-CV
Cemento cava
Cava cement

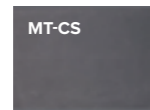

MT-CS
Cemento scuro
Dark cement

MT PREMIUM

TEXTURE / TEXTURED

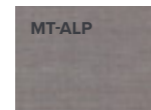

MT-ALP
Alpaca

MT PREMIUM

OPACO / MATT

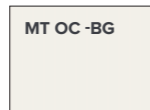

MT OC -BG
Bianco Gesso
Chalk White

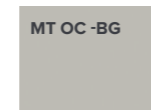

MT OC -BG
Madreperla
Mother of pearl

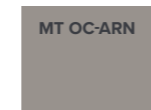

MT OC-ARN
Arena



MT OC-BA
Basalto
Basalt

Anta Gate disponibile in finitura materico e vetro.
Anta Bridge disponibile solo in vetro.
The Gate door is available with a textured or glass finish.
The Bridge door is only available in glass.

DIMENSIONE ANTA / DOOR SIZE

L. max 150 (per finiture vetro)

L. max 120 (per finiture materiche)

H. max 300

Max. W. 150 (for glass finishes)

Max. W. 120 (for textured finishes)

Max H. 300

VETRI / GLASS

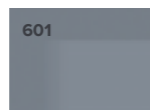

601
Fumè
Smoked

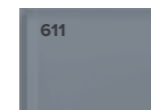

611
Fumè satinato
Satin smoky grey

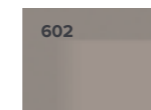

602
Bronzo
Bronze

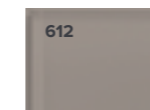

612
Bronzo satinato
Satin bronze

CONFIGURAZIONI / CONFIGURAZIONI

BINARIO 1 VIA ESTERNO VANO 1-WAY TRACK OUTSIDE OPENING

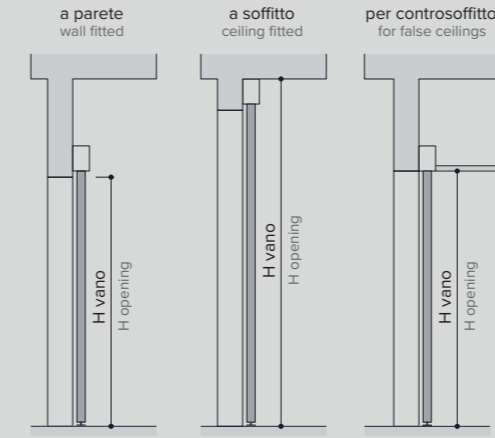

Vista laterale Side view

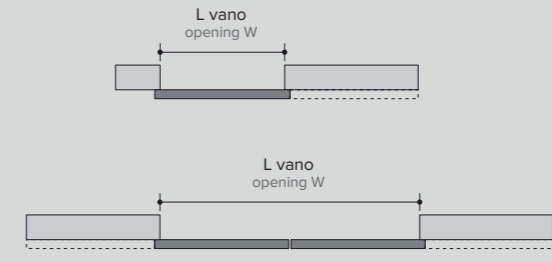

Vista in pianta Plan view

BINARIO 2 VIE ESTERNO VANO 2-WAY TRACK OUTSIDE OPENING

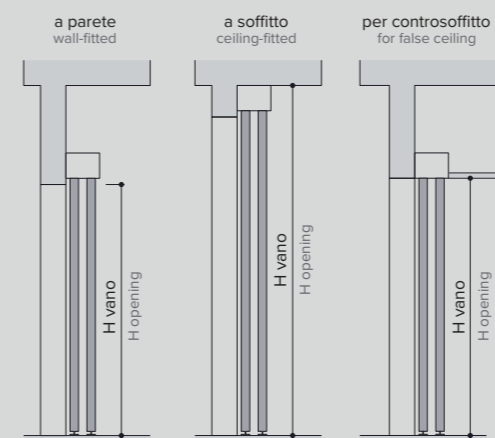

Vista laterale Side view

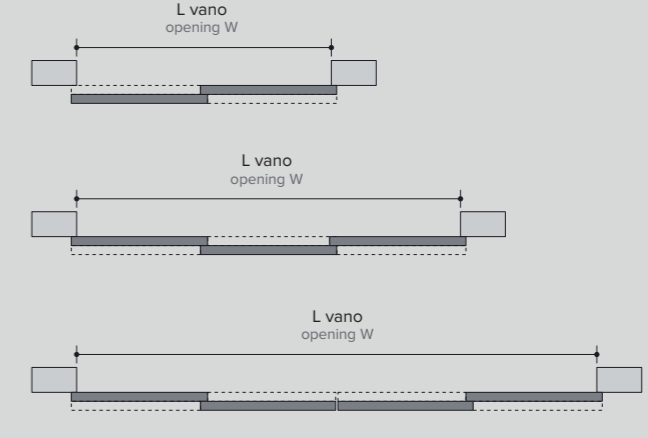

Vista in pianta Plan view

BINARIO 2 VIE INTERNO VANO 2-WAY TRACK INSIDE OPENING

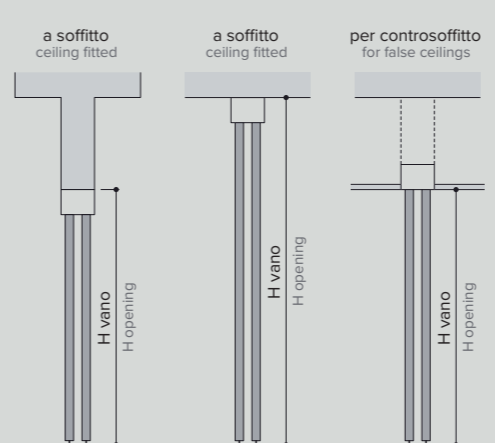

Vista laterale Side view

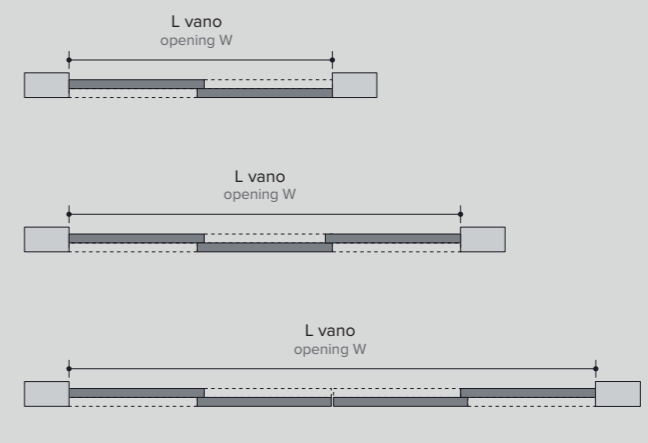

Vista in pianta Plan view

LETTI E CONTENITORI ELEGANT MOOD

Elegant mood _ beds and bedroom furniture

Venature intense, effetti materici e tonalità rilassanti si posano sulla notte e la caratterizzano con contrasti decisi e allo stesso tempo armoniosi. La camera da letto diventa un luogo intimo e personale nel quale dormire sonni tranquilli, ma anche trovare spazi tutti per sé.

Striking grains, textured effects and relaxing shades dominate the sleeping area, offering bold yet harmonious contrasts. The bedroom becomes an intimate and personal place, where you can sleep peacefully, but also find spaces all for yourself.

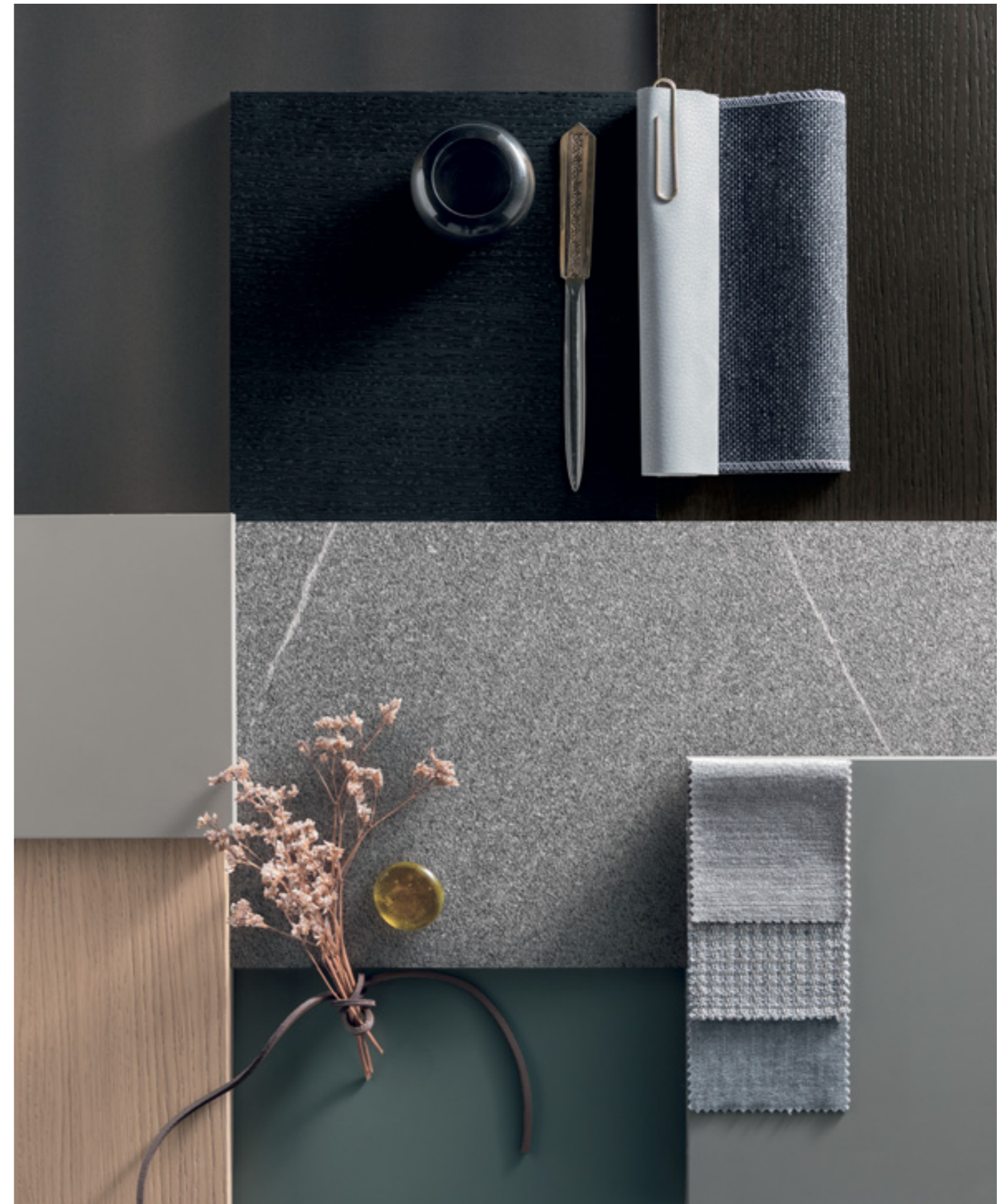

ARGO DAFNE



Oltre al comò a tre cassetti, comodini e al settimanale la collezione Argo ha inedite configurazioni: Il comodino è disponibile nella versione large e il comò con il top scorrevole che diventa un funzionale scrittoio. I contenitori notte Argo sono disponibili con top spessore 6 o 2 cm. Dafne è il letto dalla personalità sofisticata con l'imbottitura capitonné.

In addition to the 3-drawer chest-of-drawers, bedside units and the narrow chest, the Argo collection offers new layouts: The bedside unit is available in a large version and the chest of drawers has a sliding top that becomes a writing desk. Argo storage units for the sleeping area are available with 6 or 2 cm thick tops. Dafne is the bed with a sophisticated personality, with upholstery in capitonné quilting.





Il comò Argo ha un piano che scorre agevolmente sul top per creare all'interno della camera da letto un pratico angolo home office o una stilosa postazione make up. Il piano può essere personalizzato con una finitura diversa dal contenitore per accentuare ulteriormente la sua presenza.

The Argo chest of drawers has a top that easily slides over the surface below to create a practical home office corner or a stylish make-up table in the bedroom. The top can be customised with a different finish from the chest of drawers to further enhance its appearance.





HALIFAX letto / bed
Materico rovere nodato chiaro
e cuscini cat. C sancho 20.
Light knotted textured oak with cat. C
Sancho 20 cushions.

ARGO contenitori / units
Comodino materico cemento cava
Comò con top rovere nodato chiaro
e materico cemento cava.

Textured cava cement bedside table
Chest-of-drawers in textured cava
cement with a light knotted
oak top.



HASHTAG

HALIFAX

Più di un letto, Halifax è un vero e proprio elemento d'arredo: la testiera è formata da pannellature con e senza imbottitura, che permettono di personalizzarlo con più finiture e colori. È perfetto abbinato allo stile geometrico, moderno e giovane del comodino Hashtag.

More than a bed, Halifax is a genuine furnishing element: the headboard consists of panels, with and without upholstery, allowing it to be customised with various finishes and colours. It is perfect combined with the geometric, modern and young style of the Hashtag bedside table.

HALIFAX letto / bed
Materico alpaca e cuscini
cat. B ecopelle vintage 107.
In textured alpaca with cat. B
eco-leather vintage 107 cushions.

HASHTAG contenitore / unit
Comodino materico rovere carbone,
top materico alpaca.
Textured coal oak bedside table,
textured alpaca top.

JOY tavolino / coffee table
Struttura metallo antracite 160
piano laccato opaco bromo 176.
Anthracite 160 metal structure,
matt bromine 176 lacquered top.





Il letto Halifax con il comodino Hashtag: una combinazione originale di forme, elementi e finiture che arreda una camera da letto di design. Le combinazioni cromatiche tra materico alpaca e materico carbone creano uno stile armonioso.

The Halifax bed with the Hashtag bedside unit: an original combination of shapes, elements and finishes for furnishing a stylish bedroom. The colour combinations of textured alpaca and textured coal create a harmonious style.

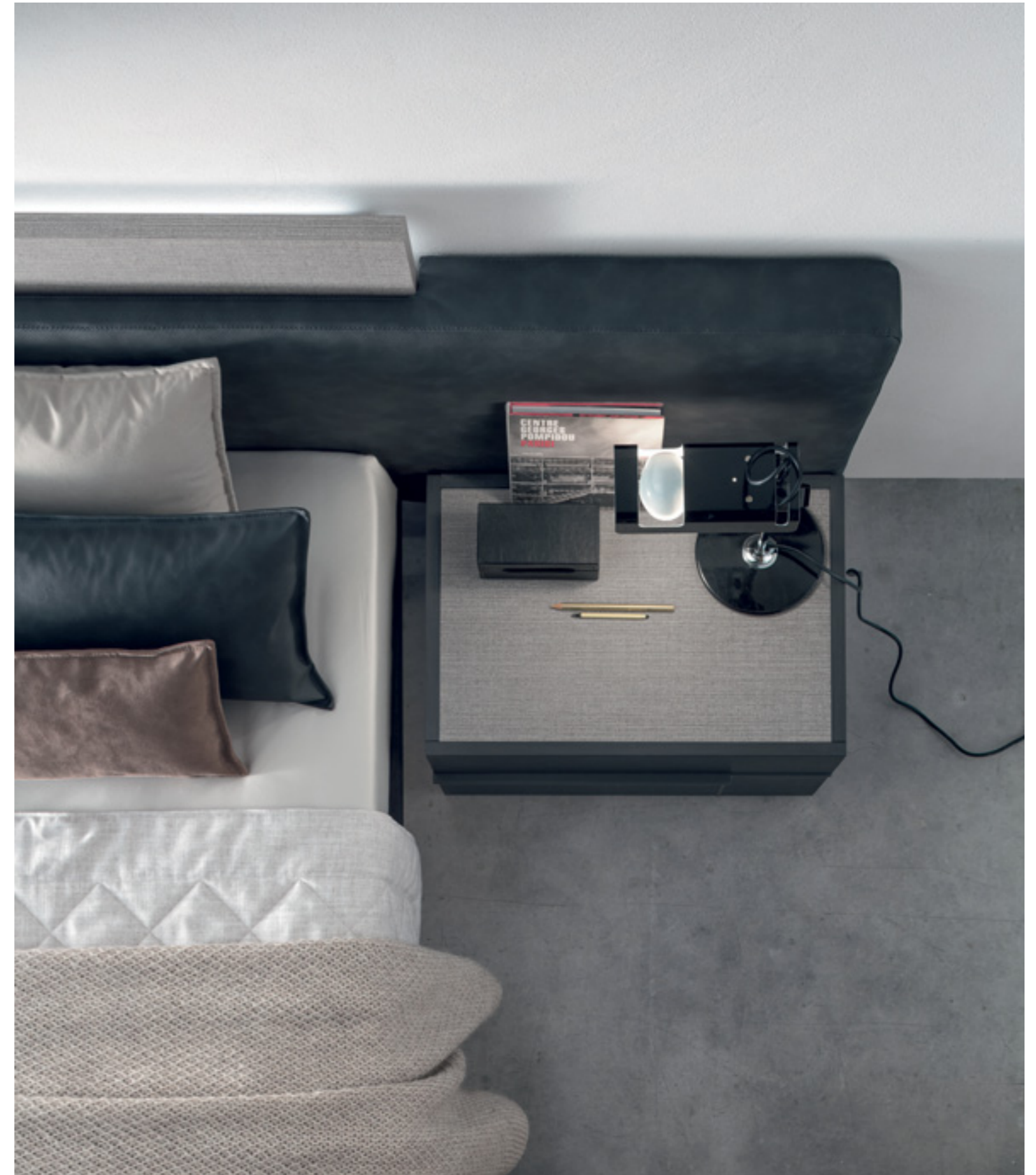

Letti e contenitori

MARLENA DOLCEVITA

Il letto Marlena ha una testiera imbottita decorata con particolari cuciture verticali, che lo rendono molto elegante. Il giroletto riprende le forme arrotondate, la finitura legno rovere moka e il basamento con piedini del comodino Dolcevita per arredare una notte dall'atmosfera raffinata.

The Marlena bed has an upholstered headboard decorated with special vertical seams for a highly elegant look. The bed frame also features rounded shapes, whereas the Mocha Oak wood finish and the base and feet of the Dolcevita bedside unit give the sleeping area a refined atmosphere.



MARLENA letto / bed
Legno rovere moka.
testiera cat. A boston ash.
Mocha oak wood
Cat. A boston ash headboard.

DOLCEVITA
contenitore / unit
Comodino legno rovere moka.
Mocha oak wood bedside table.



LETTI E CONTENITORI LIVELY MOOD

Lively mood _ beds and bedroom furniture

Venature delicate e naturali incontrano tonalità calde e vivaci per rivestire una notte moderna, giovane e accattivante.

La camera diventa uno spazio vitale in cui i sogni sono a colori e, oltre al meritato riposo, si legge o si guarda la tv comodamente distesi a letto, accolti dalla morbidezza dei tessuti.

Delicate, natural grains blend with warm, vibrant shades to furnish a modern, young and attractive sleeping area. The bedroom becomes a vital space for colourful dreams. Here, you can have a well-deserved rest, read or watch TV comfortably lying in bed, embraced by soft fabrics.



SIR FUSION

Il letto Fusion è, di nome e di fatto, una totale fusione di elementi: testiera, giroletto e comodino formano un tutt'uno di grande presenza scenica. Le spiccate geometrie e la finitura in materico noce ambra tornano nel comò Sir e la notte è estremamente coordinata.

The Fusion bed is, in name and in essence, a total fusion of elements: a headboard, bed frame and bedside unit create a spectacular overall effect. The striking shapes and amber walnut textured finish are echoed in the Sir chest of drawers, making the sleeping area extremely coordinated.

FUSION letto / bed
Struttura e comodino integrato
materico noce ambra e
testiera cat. C allure unito 03.
Structure and integrated bedside
table in textured amber walnut with
a Cat. C allure unito 03 headboard.

SIR
contenitore / unit
Materico noce ambra.
Textured amber walnut.





Nel comò Sir, il top a vassoio è un dettaglio di stile e un originale piano d'appoggio. La finitura in materico noce ambrata ammorbidisce le linee moderne e minimaliste degli arredi: nel suo insieme, la camera da letto è essenziale nella forma e naturale nella sostanza.

The tray-top of the Sir chest of drawers is both a stylish detail and an original set-down surface. The amber walnut textured finish softens the modern, minimalist lines of the furniture: the bedroom is, overall, essential in shape and natural in substance.



PIUMA REPLAY

La testiera del letto Piuma è formata da due morbidi cuscini estremamente confortevoli. Il suo carattere soft è contrastato dalle linee geometriche e dagli originali accostamenti cromatici della coppia di comodini Replay per una notte dalla marcata personalità.

The headboard of the Piuma bed consists of two soft, extremely comfortable cushions. Its soft character contrasts with the geometric lines and original colour combinations of the pair of Replay bedside units, resulting in a sleeping area with a distinctive personality.





I moduli del gruppo Replay possono essere sovrapposti e affiancati per creare combinazioni inedite e personali, valorizzate da abbinamenti di colori e materiali.

The modules of the Replay model can be stacked and fitted side-by-side to create unusual, personal combinations, enhanced by matching colours and materials.



NIKKY

La caratteristica principale del letto Nikki è data dalla presenza di cuscini con diverse configurazioni che fungono da testiera e sono perfettamente integrati a quest'ultima. Grazie alle diverse combinazioni possibili di finiture e tessuti, il letto interpreta i diversi stili abitativi e le diverse personalità di chi lo sceglie.

The main feature of the Nikki bed is its cushions in different shapes that comprise the headboard and are perfectly integrated with it. Thanks to various combinations of finishes and fabrics, the bed reflects the different living styles and personalities of those who choose it.

NIKKY letto / bed
Struttura materico rovere sabbia, cuscini cat. B ecopelle vintage 1008, cat. B ecopelle vintage 107 e cat. C allure unito 01.
Structure in textured sand oak, cushions in cat. B vintage 1008 eco-leather, cat. B vintage 107 eco-leather and cat. C allure unito 01.

FORTEBRACCIO libreria / bookcase
Struttura laccato opaco bianco gesso 121, mensole materico rovere Sabbia.
Matt chalk white 121 lacquered structure, textured sand oak shelves.





Nikki unisce il rigore della struttura alla morbidezza della testiera per arredare una camera in cui comfort e stile convivono in perfetta armonia.



Nikki combines the rigorous appeal of the structure with the softness of the headboard to furnish a bedroom where comfort and style are in perfect harmony.

FINITURE SISTEMA CABINE ARMADIO

FINISHES FOR THE WALK-IN WARDROBE SYSTEM

STAFFE, TELAI E ACCESSORI Frames, brackets and accessories

METALLI

METALS



Gris



Antracite
Anthracite

MODULI A GIORNO, BOISERIE E ATTREZZATURE Open modules, wall panelling and fittings

MT 1/ONE

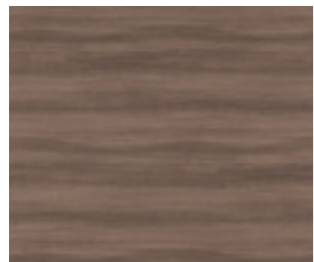

MT-NAM
Noce ambra
Amber walnut

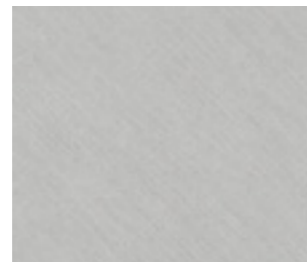

MT-CNV
Canvas

MT PREMIUM

MATERICO OPACO
MATT TEXTURED

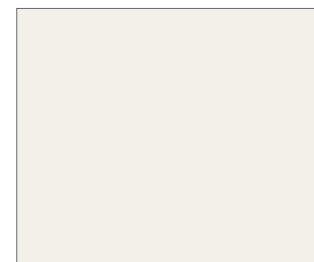

MT OC -BG
Bianco Gesso
Chalk White



MT OC -BG
Madreperla
Mother of pearl

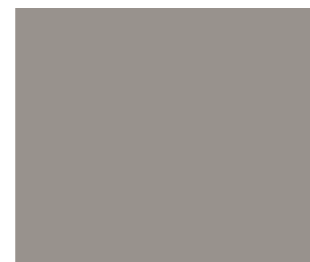

MT OC-ARN
Arena



MT OC-BA
Basalto
Basalt

MODULI A GIORNO, BOISERIE E ATTREZZATURE Open modules, wall panelling and fittings

MT PREMIUM

MATERICO ESSENZA
TEXTURED WOOD

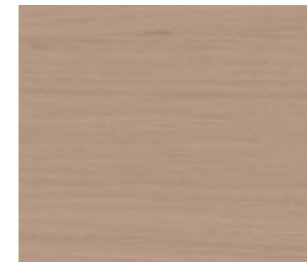

MT-RSB
Rovere sabbia
Sand oak

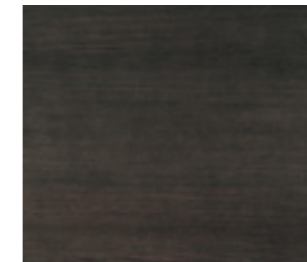

MT-RMK
Rovere moka
Mocha oak

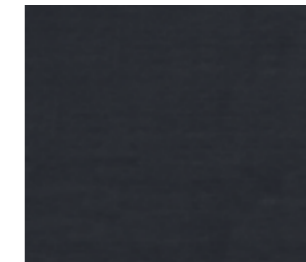

MT-RC
Rovere carbone
Coal oak



MT-RNC
Nodato chiaro
Light knotted

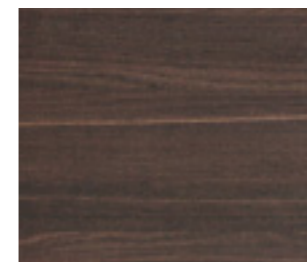

MT-RT
Rovere termocotto
Heat-treated Oak



MT-FO
Frassino oriente
Eastern ash

MT PREMIUM

MATERICO CEMENTO
TEXTURED CEMENT

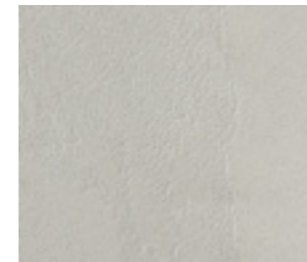

MT-CC
Cemento chiaro
Light cement



MT-CV
Cemento cava
Cava cement

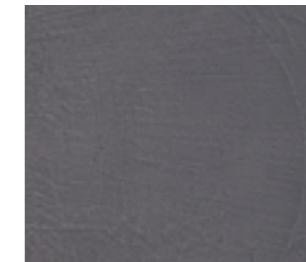

MT-CS
Cemento scuro
Dark cement

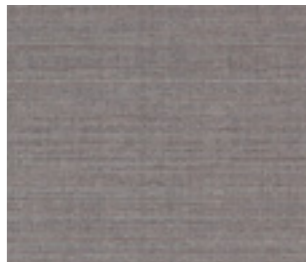

MT-ALP
Alpaca

Per finiture dei letti e dei contenitori fare riferimento al listino prezzi notte.
For bed and bedroom furniture finishes, please refer to the bedroom price list.

LACCATI OPACHI E LUCIDO / MATT AND GLOSS LACQUERS

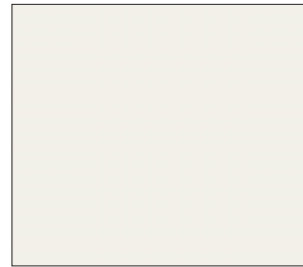

121 Bianco gesso / chalk white



162 Platino / Platinum



124 Madreperla / Mother of pearl



150 Canapa / Hemp



173 Ghiaccio / Ice



177 Basalto / Basalt



176 Bromo / Bromite



155 Carta da zucchero
Blue grey



127 Hot / Hot grey

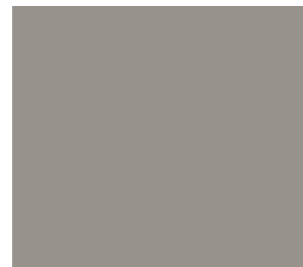

178 Arena

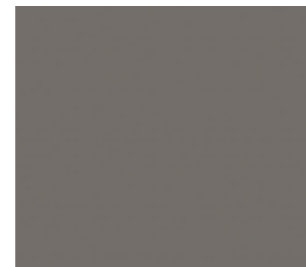

130 Grigio Piacenza
Piacenza grey

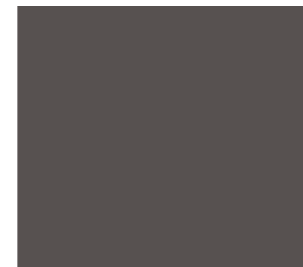

161 Fango / Mud brown



166 Mimetico / Mimetic green



167 Onice / Onyx

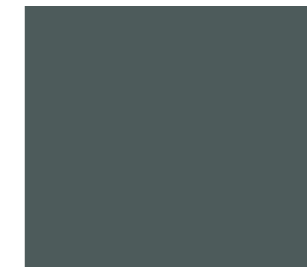

165 Mirto / Myrtle

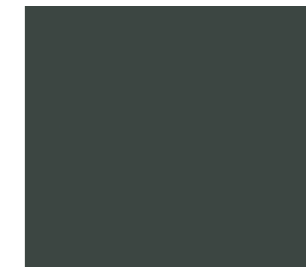

168 Bosco / Forest green



152 Pomice / Pumice



163 Salina / Salt grey



174 Fumo / Smoky grey

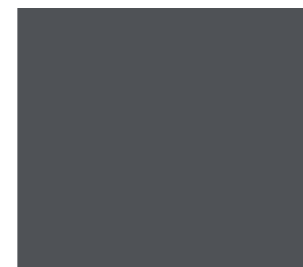

175 Lava



159 Salvia / Sage



169 Curcuma / Turmeric



158 Zafferano / Saffron

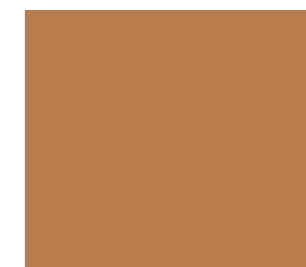

170 Terracotta



128 Smoke



160 Antracite / Anthracite

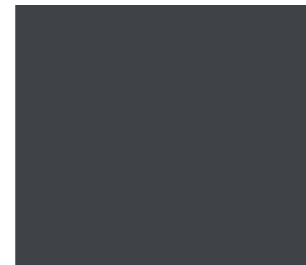

164 Ardesia / Slate



131 Nero fumo
Smoke black



157 Pesca / Peach



172 Rubino / Ruby red



171 Tabasco



156 Bordeaux / Burgundy

Páginas de síntesis
Descriptifs
Seitenübersicht

Textos en español,
francés y alemán

Textes en espagnol,
français et allemand

Texte in Spanisch,
Französisch und Deutsch

PRATICO SYSTEM

p. 8 - 9



PRATICO COMP_PR101 + COMP_PR102
COMP_PR101 L/W 247,3 P/D 34,8/59,6 H 255,8 CM
COMP_PR102 L/W 387,6/396,7 P/D 34,8/59,6 H 255,8 CM

Boiserie texturizado alpaca. Equipamiento texturizado nogal ámbar, lacado mate rubí 172 y melocotón 157. Soportes y accesorios de metal antracita.

Habillage mural en texturé alpaca. Aménagement en texturé noyer ambre et laqué mat coloris rubis 172 et pêche 157. Supports et accessoires en métal anthracite.

Wandverkleidung Rau Alpaca. Ausstattung Rau Nussbaum Bernstein, matt lackiert Rubinrot 172 und Pfirsich 157. Halterungen und Zubehörteile aus Metall Farbe Anthrazit.

p. 20 - 21



PRATICO COMP_PR103
L/W 517,8 P/D 59,6 H 255,8 CM

Boiserie texturizado canvas y texturizado roble arena. Equipamiento texturizado roble arena, cajoneras de cristal. Soportes y accesorios de metal antracita.

Habillage mural en texturé canvas et texturé chêne sable. Aménagement en texturé chêne sable, blocs tiroirs en verre. Supports et accessoires en métal anthracite.

Wandverkleidung Rau Canvas und Rau Eiche Sand. Ausstattung Rau Eiche Sand, Schubladenelemente aus Glas. Halterungen und Zubehörteile aus Metall Farbe Anthrazit.

p. 24 - 25



PRATICO COMP_PR104
L/W 519,8/478 P/D 59,6 H 255,8 CM

Boiserie texturizado canvas y texturizado mate basalto. Equipamiento texturizado roble carbón y texturizado mate basalto. Soportes y accesorios de metal antracita.

Habillage mural en texturé canvas et texturé basalte mat. Aménagement en texturé chêne charbon et texturé basalte mat. Supports et accessoires en métal anthracite.

Wandverkleidung Rau Canvas und Rau matt Basaltgrau. Ausstattung Rau Eiche Kohlegrau und Rau matt Basaltgrau. Halterungen und Zubehörteile aus Metall Farbe Anthrazit.

DOXA SYSTEM

p. 48 - 49



DOXA COMP_DO201 + COMP_DO202
DO201 L /W 375 P/D 37,8/59,5 H 255,5 CM
DO202 L /W 375 P/D 37,8/59,5 H 255,5 CM

Módulos abiertos texturizado roble carbón. Equipamiento texturizado roble carbón, lacado mate ónix 167 y mirto 165. Accesorios de metal antracita.

Modules ouverts en texturé chêne charbon. Aménagement en texturé chêne charbon et laqué onyx 167 mat. Accessoires en métal anthracite.

Offene Module Rau Eiche Kohlegrau. Ausstattung Rau Eiche Kohlegrau, matt lackiert Onyx 167 und Myrte 165. Zubehörteile aus Metall Farbe Anthrazit.

p. 56 - 57

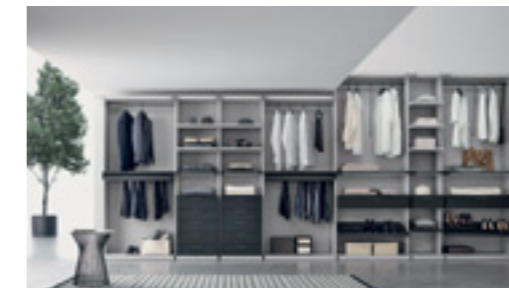

DOXA COMP_DO203
L /W 574,3 P/D 37,8/59,5 H 223,5/255 CM

Módulos abiertos texturizado canvas. Equipamiento texturizado roble carbón. Accesorios de metal antracita.

Modules ouverts en texturé canvas. Aménagement en texturé chêne charbon. Accessoires en métal anthracite.

Offene Module Rau Canvas. Ausstattung Rau Eiche Kohlegrau. Zubehörteile aus Metall Farbe Anthrazit.

p. 63



DOXA COMP_DO204
L /W 450,5/310,8 P/D 37,8/59,5 H 255,5 CM

Módulos abiertos texturizado alpaca, equipamiento texturizado nogal ámbar. Accesorios de metal antracita.

Modules ouverts en texturé Alpaca, aménagement en texturé noyer ambre.

Offene Module Rau Alpaca, Ausstattung Rau Nussbaum Bernstein. Zubehörteile aus Metall Farbe Anthrazit.

LIBERTY SYSTEM

p. 80 - 81

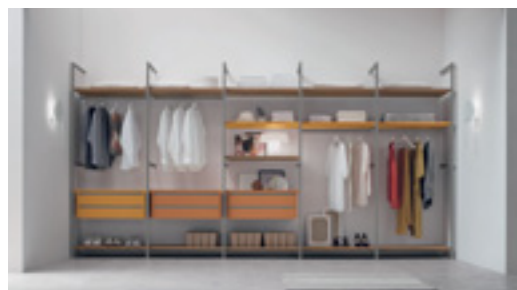

LIBERTY COMP_LI301
L / W 465 P/D 59,5 H 239 CM

Bastidor metal gris. Equipamiento texturizado con nudos claro, lacado mate cúrcuma 169 y terracota 170.

Montants en métal gris. Aménagement en texturé chêne à nœuds clair et laqué mat coloris curcuma 169 et terre cuite 170.

Rahmen aus Metall Farbe Gris. Ausstattung Rau astig hell, matt lackiert Kurkuma 169 und Terracotta 170.

p. 86 - 87

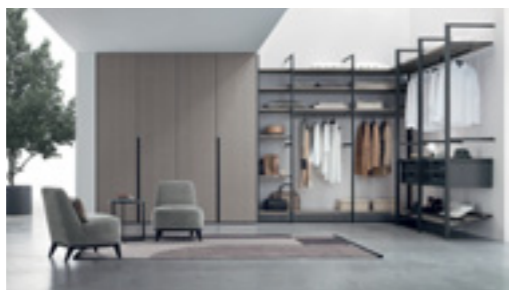

LIBERTY COMP_LI302
L / W 249,5/291,8 P/D 59,5 H 255 CM
(EXCLUIDO ARMARIO / HORS ARMOIRE
AUSGENOMMEN SCHRANK)

Armario batiente puerta Doris. Acabado estructura texturizado alpaca. Tirador integrado metal antracita. Bastidores metal antracita. Equipamiento texturizado alpaca, cajoneras lacado mate antracita 160 con frentes de cristal.

Armoire à portes battantes Doris. Structure en texturé alpaca. Poignée intégrée en métal anthracite. Montants en métal anthracite. Aménagement en texturé Alpaca, blocs-tiroirs en laqué anthracite 160 mat avec façades en verre.

Schrank mit Drehtür Doris. Ausführung der Struktur Rau Alpaca. Integrierter Griff aus Metall Farbe Anthrazit. Rahmen aus Metall Farbe Anthrazit. Ausstattung Rau Alpaca, Schubladenelemente matt lackiert Anthrazit 160 mit Fronten aus Glas.

p. 92 - 93

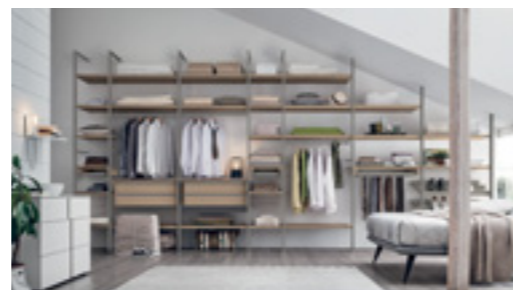

LIBERTY COMP_LI303
L / W 571,4 P/D 59,5 H 255 CM

Bastidores gris. Equipamiento texturizado roble arena.

Montants en métal gris. Aménagement en texturé chêne sable.

Rahmen Farbe Gris. Ausstattung Rau Eiche Sand.

DOORS - OPEN SYSTEM

p. 109



COMP_D901
L / W 360 H 270 CM

APERTURA PLEGABILE
Puerta Bridge acabado perfil brown, panel de cristal fumé 601.

OUVERTURE PLIANTE
Porte Bridge avec profil finition Brown et panneau en verre fumé 601.

ÖFFNUNG MIT FALTTÜR
Tür Bridge Profil Ausführung Brown, Platte aus Rauchglas 601.

p. 113



COMP_D902
L / W 180 H 270 CM

APERTURA CORREDERA SUSPENDIDA
Puerta Gate acabado perfil brown, panel de cristal bronce 602.

OUVERTURE COULISSANTE SUSPENDUE
Porte Gate avec profil finition Brown et panneau en verre bronze 602.

ÖFFNUNG MIT HÄNGENDER SCHIEBETÜR
Tür Gate Profil Ausführung Brown, Platte aus Glas in Bronzeoptik 602.

p. 117



COMP_D903
L / W 480 H 270 CM

APERTURA CORREDERA DE SUELO
Puerta Gate acabado perfil brown, panel en texturizado Alpaca.

OUVERTURE COULISSANTE AU SOL
Porte Gate avec profil finition brown et panneau en texturé alpaca.

ÖFFNUNG MIT BODENGEFÜHRTER SCHIEBETÜR
Tür Gate Profil Ausführung Brown, Platte Rau Alpaca.

ACCESSORISED ISLAND DRAWER UNITS

p. 102



L / W 184,8 P/D 86 H 70,5 CM

Isla equipada, compartimentos abiertos en acabado texturizado roble moka. Sofá integrado. Cajones y encimera en cristal fumé 601.

Îlot aménagé avec modules ouverts finition texturé chêne moka. Banquette intégrée. Tiroirs et plateau en verre fumé 601.

Ausgestattetes Inselmodul, offene Fächer in Ausführung Rau Eiche Mokka. Integriertes kleines Sofa. Schubladen und Abdeckplatte aus Rauchglas 601.

p. 104



L / W 275,5 P/D 96,4 H 70,5 CM

Isla equipada con cajones y compartimentos abiertos lacado mate rubí 172 y texturizado nogal ámbar. Encimera en cristal fumé 601.

Îlot aménagé avec tiroirs et modules ouverts en laqué rubis 172 mat et texturé noyer ambre. Plateau en verre fumé 601.

Ausgestattetes Inselmodul mit Schubladen und offenen Fächern in matt lackiert Rubinrot 172 und Rau Nussbaum Bernstein. Abdeckplatte aus Rauchglas 601.

p. 105



L / W 184,8 P/D 49,7 H 70,5 CM

Isla equipada en un lado con cajones y compartimentos abiertos texturizado nogal ámbar. Encimera en cristal fumé 601.

Îlot aménagé sur 1 côté avec tiroirs et modules ouverts en texturé noyer ambre. Plateau en verre fumé 601.

Auf einer Seite ausgestattetes Inselmodul mit Schubladen und offenen Fächern in Rau Nussbaum Bernstein. Abdeckplatte aus Rauchglas 601.

p. 105



L / W 144 P/D 49,7 H 70,5 CM

Isla equipada compartimentos abiertos texturizado nogal ámbar. Encimera y cajones en cristal fumé 601.

Îlot aménagé avec modules ouverts en texturé noyer ambre. Tiroirs et plateau en verre fumé 601.

Ausgestattetes Inselmodul mit offenen Fächern in Rau Nussbaum Bernstein. Abdeckplatte und Schubladen aus Rauchglas 601.

CAMAS Y CONTENEDORES
LITS ET MEUBLES DE
CHAMBRE À COUCHER
BETTEN UND BEIMÖBEL

p. 124 - 125



DAFNE cama Cat. B econobuk 13. ARGÓ C3moda con superficie extraíble texturizado Roble Carb3n y lacado mate mirto 165. Mesita de noche texturizado roble carb3n.

DAFNE lit. Cat. B 3conubuk 13. ARGÓ meubles de chambre. Commode en laqu3 myrte 165 mat avec plateau coulissant en textur3 ch3ne charbon. Chevet en textur3 ch3ne charbon.

DAFNE Bett. Kat. B Econabuk 13. ARGÓ Kommode mit ausziehbarer Platte Rau Eiche Kohlegrau und matt lackiert Myrte 165. Nachttisch Rau Eiche Kohlegrau.

p. 129

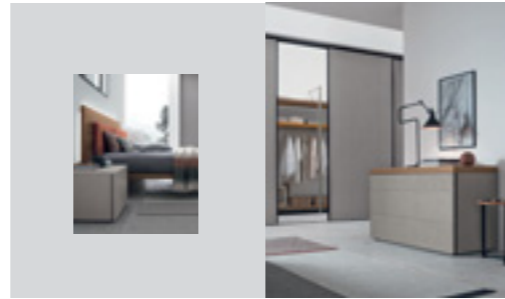

HALIFAX cama. Texturizado roble con nudos claro y cojines cat. C sancho 20. ARGÓ contenedores. Mesita de noche texturizado cemento cantera. C3moda con encimera roble con nudos claro y texturizado cemento cantera.

HALIFAX lit. Textur3 ch3ne 3 no3uds clair et coussins cat. C sancho 20. ARGÓ meubles de chambre. Chevet en textur3 ciment carri3re. Commode en textur3 ciment carri3re avec plateau en ch3ne 3 no3uds clair.

HALIFAX Bett. Rau Eiche astig hell und Kissen Kat. C Leinen Sancho 20. Beim3bel ARG3S. Nachttisch Rau Zement cava. Kommode mit Abdeckplatte Eiche astig hell und Rau Zement cava.

p. 146 - 147



PIUMA cama. Estructura texturizado nogal 3mbar cojines cat. C allure unito 105. REPLAY contenedores. Mesitas de noche texturizado nogal 3mbar, encimera cristal satinado tabasco 471. C3moda texturizado nogal 3mbar, texturizado alpaca y encimera cristal satinado satinado tabasco 471.

PIUMA lit. Structure en textur3 noyer ambre, coussins cat. C allure unito 105. REPLAY meubles de chambre. Chevets en textur3 noyer ambre avec plateau en verre satin3 tabasco 471. Commode en textur3 noyer ambre, textur3 alpaca et plateau en verre satin3 tabasco 471.

PIUMA Bett. Struktur Rau Nussbaum Bernstein Kissen Kat. C Allure Unito 105. Beim3be REPLAY. Nachttische Rau Nussbaum Bernstein, Abdeckplatte satiniertes Glas Tabasco 471. Kommode Rau Nussbaum Bernstein, Rau Alpaca und Abdeckplatte satiniertes Glas Tabasco 471.

p. 150 - 151



NIKKY cama. Estructura texturizado roble arena,cojines cat. B ecopiel vintage 1008, cat. B ecopiel vintage 107 y cat. C allure unito 01. FORTEBRACCIO librer3a. Estructura lacado mate blanco yeso 121, estantes texturizado roble arena.

NIKKY lit. Structure en textur3 ch3ne sable, coussins cat. B 3cocoir vintage 1008, cat. B 3cocoir vintage 107 et cat. C allure unito 01. FORTEBRACCIObiblioth3que Structure en laqu3 blanc craie 121 mat, 3tag3res en textur3 ch3ne sable.

NIKKY Bett. Struktur Rau Eiche Sand,Kissen Kat. B Lederimitat Vintage 1008,Kat. B Lederimitat Vintage 107 und Kat. C Allure Unito 01. FORTEBRACCIO B3cherregal. Struktur matt lackiert Gipswei3 121, Borde Rau Eiche Sand.

p. 130 - 131



HALIFAX cama. Texturizado alpaca y cojines Cat. B ecopiel vintage 107. HASHTAG Mesita de noche. Texturizado roble carb3n,encimera texturizado alpaca.

HALIFAX lit. Textur3 Alpaca et coussins cat. B 3cocoir vintage 107. HASHTAG Meubles de chambre. Chevet en textur3 ch3ne charbon avec plateau en textur3 alpaca.

HALIFAX Bett. Rau Alpaca und Kissen Kat. B Lederimitat Vintage 107. HASHTAG Nachttisch Rau Eiche Kohlegrau, Abdeckplatte Rau Alpaca.

p. 136 - 137



MARLENA cama. Roble moka cabecero cat. A boston ash DOLCEVITA contenedores. Mesita de noche madera roble moka.

MARLENA lit. En bois de ch3ne moka t3te de lit cat. A Boston ash. DOLCEVITA meubles de chambre. Chevet en bois de ch3ne moka.

MARLENA Bett. Holz Eiche Mokka. Kopfteil Kat. A Boston Ash. Beim3bel DOLCEVITA. Nachttisch Holz Eiche Mokka.

p. 140 - 141



FUSION cama. Estructura y mesita de noche integrada texturizado nogal 3mbar y cabecero cat. C allure unito 03. SIR contenedores. Texturizado nogal 3mbar.

FUSION lit. Structure et chevet int3gr3 en textur3 noyer ambre et t3te de lit cat. C allure unito 03. SIR meubles de chambre. chambre en textur3 noyer ambre.

FUSION Bett. Struktur und integrierter Nachttisch Rau Nussbaum Bernstein und Kopfteil Kat. C Allure Unito 03. Beim3bel SIR. Rau Nussbaum Bernstein.

Para los acabados de las camas y de los contenedores, consultar la tarifa de los dormitorios.

Pour les finitions des lits et des meubles, consulter le tarif des chambres 3 coucher.

Hinsichtlich der Ausf3hrungen der Betten und Beim3bel verweisen wir auf die Preisliste Schlafbereich.

E' vietata ogni riproduzione totale
e parziale in Italia e all'estero.

Reproduction of all or any part of this
publication in Italy or in any other
country is prohibited.



product design
ROSSI & CO.
art direction and styling
ROSSI & CO.
graphic design
ROSSI & CO.
rendering
ROSSI & CO.
photography
STUDIO INDOOR
color separation
Z13
print
OGM



tomasella.it